

SERVICE MANUAL



Ver 1.0



ISSUE DATE: Aug. 24, 2012



- ▶ Please read the manual carefully and keep it in mind before using this machine.
- ▶ Put this manual within touch of your reference in anytime.

PRECAUTIONS FOR USE

The following safety precautions are given throughout this manual. They must be strictly followed to protect those who install, use or maintain this product as well as to protect players, visitors and property.

For safety reasons.

- The following suggestions should be adhered to:



WARNING

Disregarding could result in serious injury.



CAUTION

Disregarding could result in injury or product damage.

- The following graphic suggestions describe the types of precautions to be followed.



Indicates a care should be taken.



Forbidden.



Indicates a matter which must be performed.

- **Precautions to be followed:**

Certain procedures require a qualified in-shop maintenance person or industry specialist. For such instructions, a qualified person must take care of the jobs.

- Otherwise an electric shock, machine trouble, or a serious accident may result.
- Replacing the machine parts, inspecting and maintaining the machines, and troubleshooting must be assigned only to a qualified in-shop maintenance person or industry specialist. This booklet gives instructions that hazardous jobs in particular must be handled by an industry specialist. Qualified in-shop maintenance person and industry specialist are defined as follows.

Qualified in-shop maintenance person

- A service staff shall have experience in operations of game machines. The staff shall be responsible for assembly, installation, inspection and maintenance of the machine.

Industry specialist

- An industry specialist must be engaged in designing, manufacturing, inspecting and servicing amusement machines. He or she must have an education in electrical, electronic and mechanical engineering, and routinely maintain and repair amusement machines.

PRECAUTIONS FOR USE

WARNING

Be sure to consult an industry specialist when setting up, moving or transporting this product.

- This product should not be set up, moved or transported by any one other than an industry specialist.
- When installing this product, set the 4 leg levelers evenly on the floor and make sure that the product is installed stably in a horizontal position. Unstable installation may result in injury or accident.
- When installing this product, do not apply undue force on movable parts. Otherwise, injury and accident may result, or the product may be damaged.

The machine for indoor usage only does not install outside.



Do not set the game machine up near emergency exits.



Protect the game machine from:

- Rain or moisture.
- Direct sunlight.
- Direct heat from air-conditioning and heating equipment, etc..
- Hazardous flammable substances.
- Otherwise an accident or malfunction may result.



Do not place containers holding chemicals or water on or near the game machine.



Do not place objects near the ventilating holes.



Do not bend the power cord by force or place heavy objects on it.



Never plug or unplug the power cord with wet hands.



Never unplug the game machine by pulling the power cord.



CAUTION

Be sure to use indoor wiring within the specified voltage requirements. For extension cord, use the specified rating or more.

Be sure to use the attached power cord.

Never plug more than one cord at a time into the electrical receptacle.



Do not lay the power cord where people walk through.



Be sure to ground this product.



Do not exert excessive force when moving the machine.



For proper ventilation, keep the game machine 100mm(4") away from the walls.

Do not alter the system related dipswitch settings.

PRECAUTIONS FOR USE

WARNING

If there is any abnormality such as smoke, bad smell or abnormal noise being emitted from the machine, immediately turn OFF the main power switch and unplug the power cord from the receptacle to stop operating it. 

- Using the machine in abnormal conditions could result in fire or accidents.

In case of abnormality

1. Turn OFF the main power switch.
2. Unplug the power cord from the receptacle.
3. Contact your nearest dealer.

Do not leave the power cord plugged in improperly or covered with dust. 

- Doing so could result the power cord periodically.

CAUTION

Do not use this product anywhere other than industrial areas. 

- Using in a residential area or an area next to a residential area could affect signal reception of radios, television sets, telephones, etc..

- Do not give shock the surface of glass products.

- Please do not play this game if

- When you do drinking;
- When your physical condition is not normal;
- When you are in pregnancy;
- When you have on a pulse controller;
- When you have recently experienced a cramp or fainting away while watching TV.

- Avoid excessive force/shock while playing/moving the game.

- While do games, pay attention to surrounding.

Do not plug or unplug the power cord with wet hands. 

In handling the power cord, follow the instructions below. 

- | | |
|---|--|
| • Do not damage the power cord. | • Do not modify the power cord. |
| • Do not bend the power cord excessively. | • Do not twist the power cord. |
| • Do not heat the power cord. | • Do not pull the power cord. |
| • Do not bind the power cord. | • Do not stand on the power cord. |
| • Do not sandwich the power cord. | • Do not drive a nail into the power cord. |

If the power cord or power plug becomes damaged, stop using the machine immediately and ask your nearest dealer to replace the parts.

- * **Electromagnetic wave may cause unexpected noise from speaker.**

PRECAUTIONS FOR USE

WARNING

Be sure to turn OFF the main power switch and unplug the power cord from the receptacle before inspecting or cleaning the machine. 

When replacing parts, be sure to use parts of the correct specifications. Never use parts other than the specified ones. 

Opening inside the machine shall be done by machine specialist only as high electric current is being sent inside. For game machine with monitor, a care should be taken while opening its back door. If not, a damage to the inside parts or the monitor may occur. 

If the sub power switch of the service panel is turned OFF without turning OFF the main power switch of the power supply unit, some parts in the units remain live. When opening the back door, be sure to turn OFF the main power switch and unplug the power cord from the receptacle. 

Strictly refrain from disassembly and repair of parts which are not indicated in this manual, as well as settings and remodeling. 

To clean the game machine, wipe it with a soft cloth dampened in a neutral detergent.

- Using thinner or other organic solvent or alcohol may decompose the material.
- Electrical shock or equipment failure could be caused by water entering the inside of the machine.

CAUTION

Components in the game are sensitive to vibrations and impact. Care should be used when moving and transporting the game machine. 

Be sure not to let the machine tip over.

Before moving the machine, be sure to turn OFF the main power switch, unplug the power cord from the receptacle and remove the power cord from the machine. 

Before moving take the machine, off the levelers and move it on the casters.

Avoid excessive force while moving the machine.

.....

PRECAUTIONS IN HANDLING

- When setting up, inspecting, maintaining, moving or transporting this product, follow the procedures and instructions set forth in this manual and perform such work safely.
- Do not set up, handle, inspect, maintain, move or transport this product under conditions equivalent to the condition of "WARNING" or "CAUTION" specified in this manual.
- If a new owner is to have this product as a result of transfer, etc., be sure to give this manual to the new owner.

CONTENTS

1. SPECIFICATION AND DIMENSION02	9. TROUBLESHOOTING18
1-1. DIMENSION02	9-1. SCREEN PROBLEM18
1-2. SPECIFICATION02	9-2. SOUND ERROR19
1-3. NAME OF PARTS03	9-3. AC LAMP ERROR20
1-4. STICKER LOCATION04	9-4. OUT OF POWER21
[COMPONENTS]04	9-5. COIN SELECTOR ERROR22
2. INSTALLATION05	9-6. BUTTON & COUNTER ERROR23
3. PRODUCT CHARACTERISTICS06	9-7. MALFUNCTION OF WHEN BUTTON LED PCB & FRONT LIGHT DECO PCB ASS'Y24
4. HOW TO PLAY06	9-8. MALFUNCTION OF TICKET DISPENSER25
[WARNING]07	10. PART LIST26
5. SETUP SETTINGS07	10-1. EXPLODED VIEW26
5-1. MACHINE SETUP07	10-2. LIST27
6. SETUP MENU08	10-3. PICTURE28
6-1. BOOKKEEPING09	11. WIRING DIAGRAM	
6-2. GAME SETTING10		
6-3. TEST MODE13		
6-4. INITIALIZATION14		
6-5. ERROR MESSAGE15		
7. HOW TO REPLACE MAJOR COMPONENTS16		
REPLACEMENT OF BUTTON LED PCB ASS'Y & BUTTON16		
REPLACEMENT OF MAIN BOX & IO & DISPLAY MAIN PCB ASS'Y16		
REPLACEMENT OF FRONT LIGHT DECO PCB ASS'Y17		
8. HOW TO REPLACE CONSUMABLES17		
REPLACEMENT OF LAMP17		



1. SPECIFICATION AND DIMENSION

1-1. DIMENSION

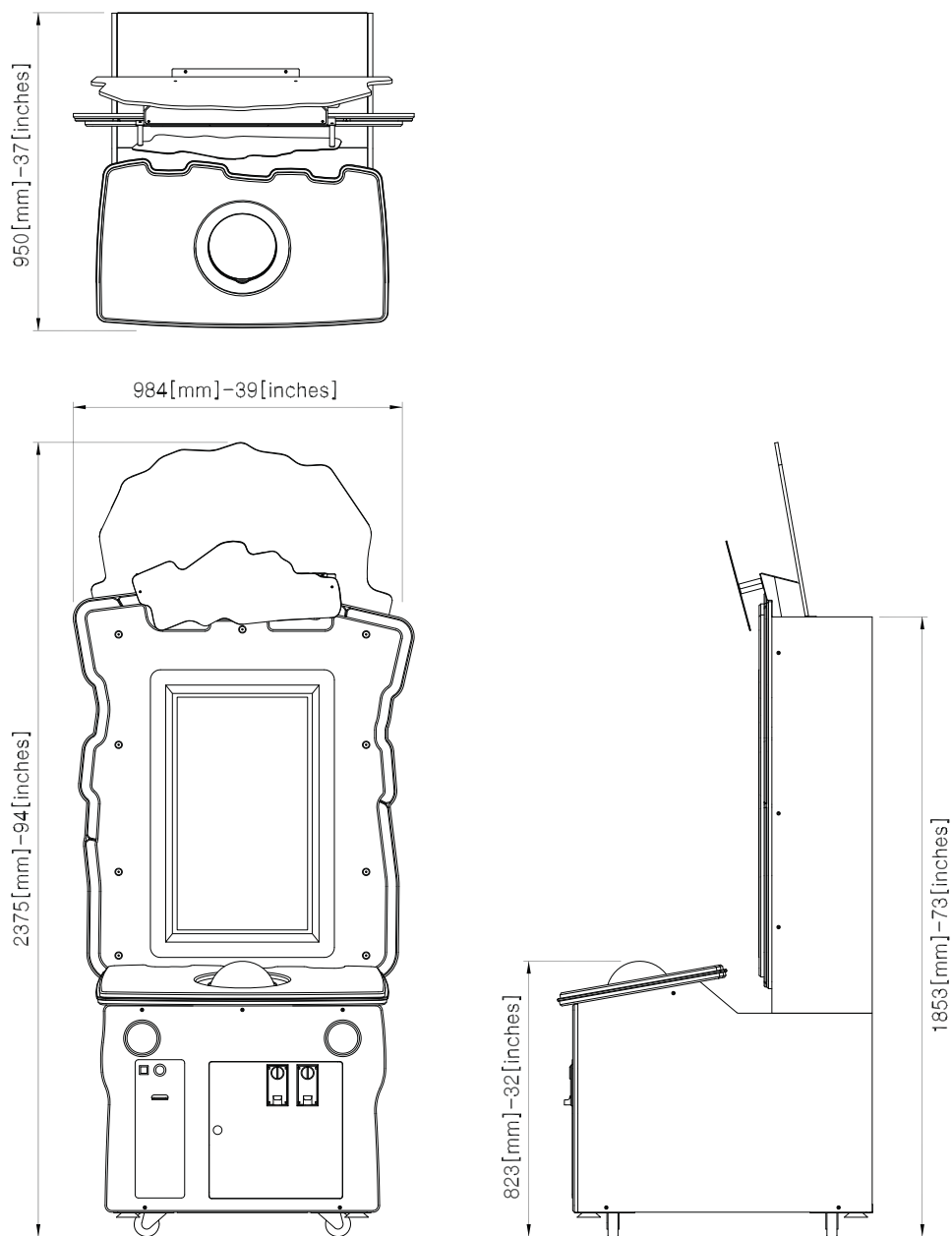

1-2. SPECIFICATION

DIMENSION (W x D x H)	984 x 950 x 1853 (mm)	
PACKING DIMENSION (W x D x H)	1150 x 1080 x 2140 (mm)	
WEIGHT (kg)	130 kg [WEIGHT INCLUDING PACKAGING : 150 kg]	
VOLTAGE	AC 120V	AC 220V
FREQUENCY RANGE	60 Hz	60 Hz
CONSUMPTION	300W	310W
CERTIFICATION	UL22	EK



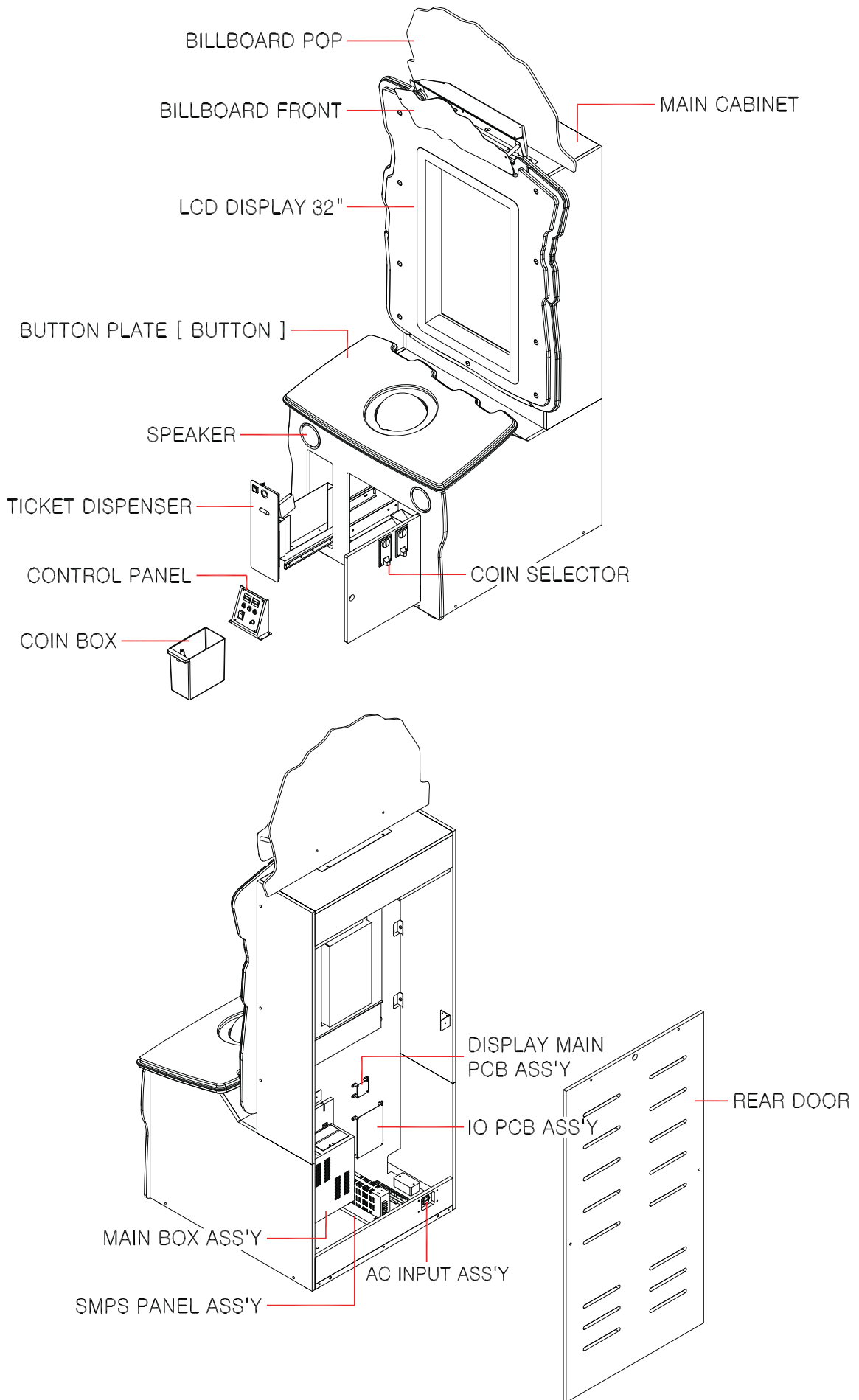

1-3. NAME OF PARTS

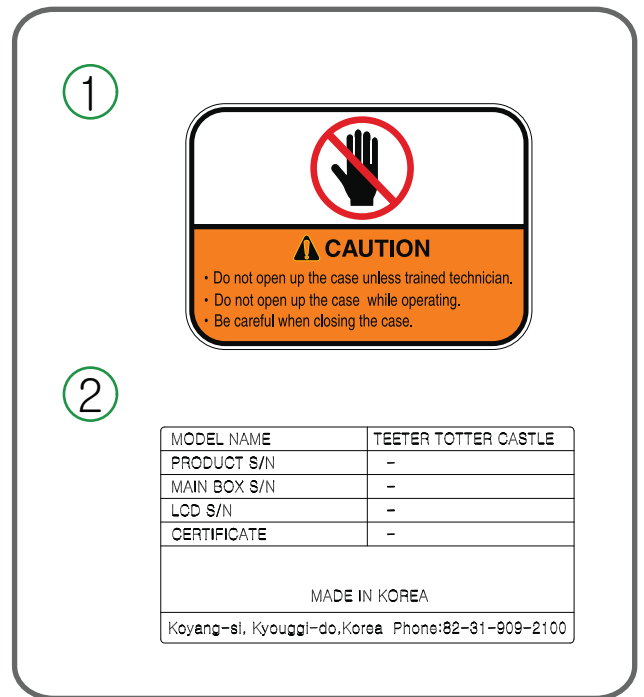
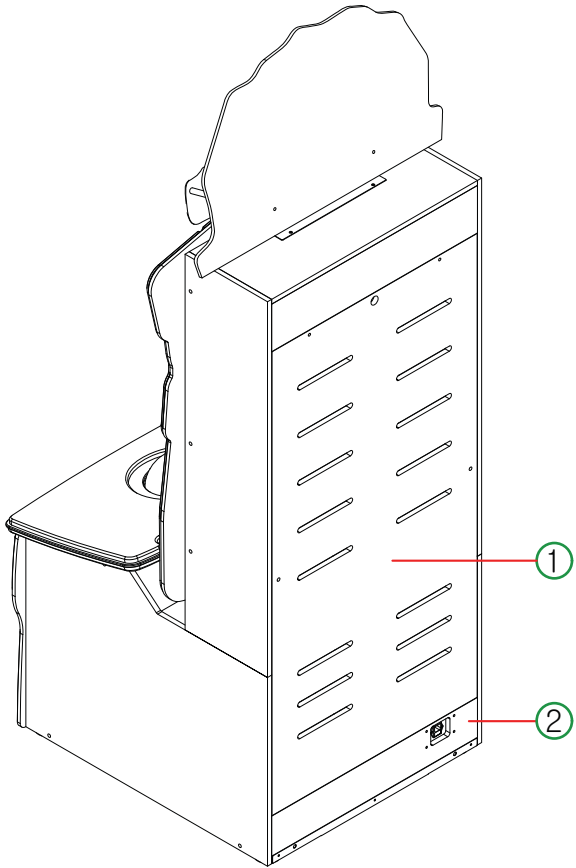

1-4. STICKER LOCATION

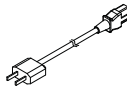

COMPONENTS

NO.	PART NAME	SPEC.	QTY
1	AC POWER CORD	110V or 220V 	1
2	KEY	6001 	2
3	KEY	7001 	2
4	WRENCH	4mm 	1
5	MANUAL	- 	1

2. INSTALLATION

1-1. INSTALLATION SPACE

- Please make sure to reserve installation space as following.
Game play AREA : more than 1500mm
Maintenance AREA : more than 2000mm

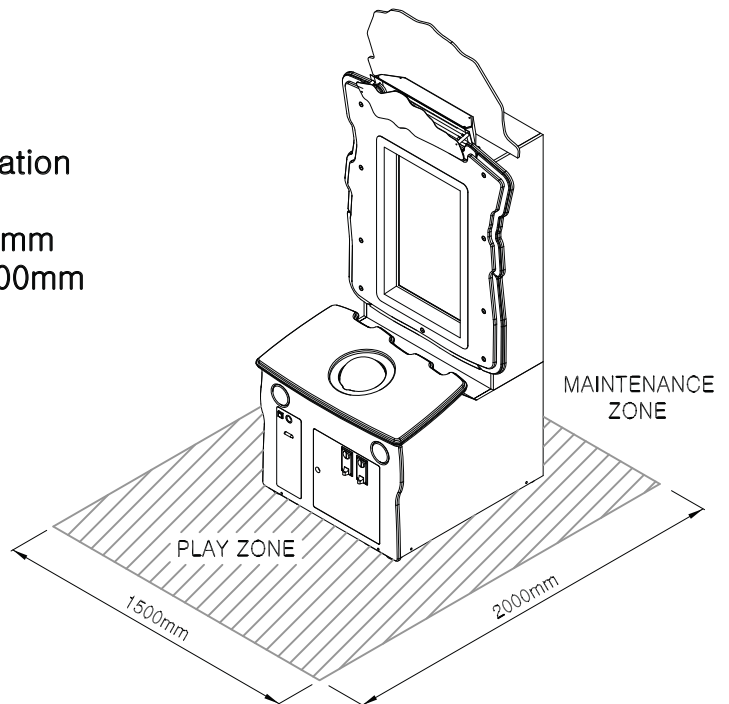

1-2. HOW TO INSTALL

1

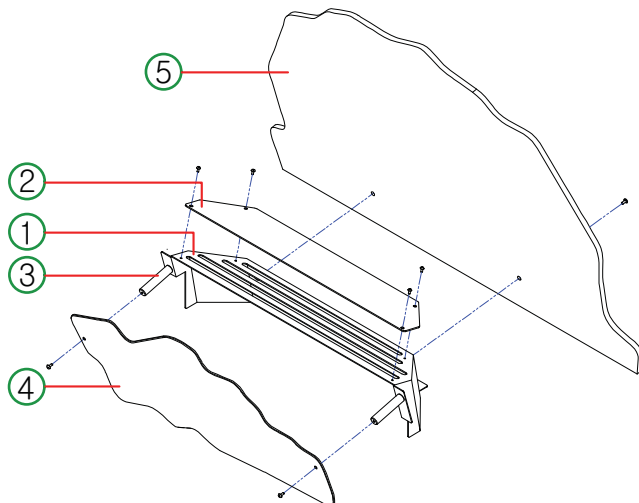

2

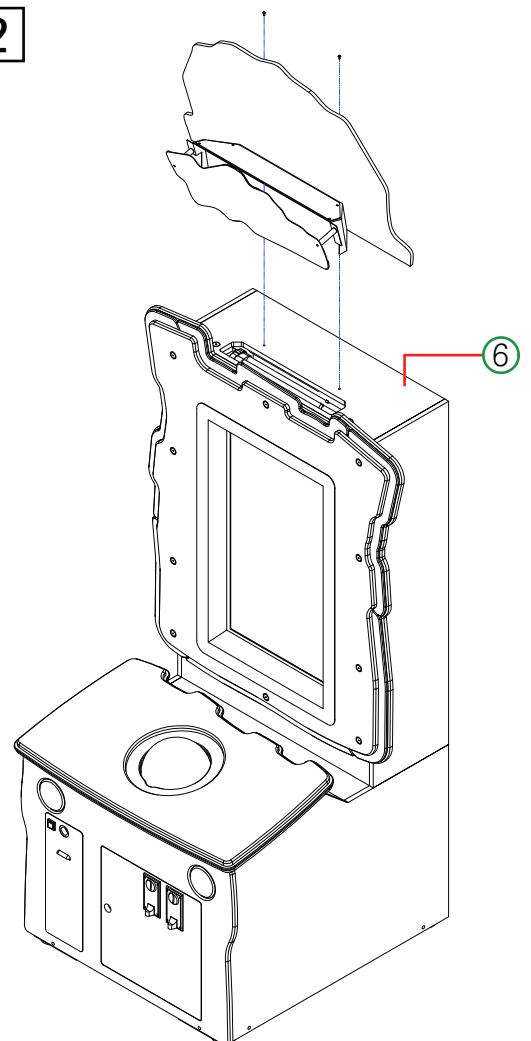

- 1) Assemble ② BILLBOARD BRACKET COVER ACRYL into ① BILLBOARD BRACKET [M4 bolt, 4ea]
- 2) Assemble ④ BILLBOARD FRONT & ⑤ BILLBOARD REAR POP [M4 bolt, 2ea] after putting ③ BILLBOARD FIX SHAFT [M6 Bolt, 2Ea]
*** Please make sure direction of Shaft**
- 3) After completion of Billboard Ass'y, place it on location ⑥ and fasten ②

3. GAME CHARACTERISTICS

3-1. Children and family friendly design

3-2. Really simple and intuitive game to play

3-3. Easy setup and Payout stability is attained by using reliable high tech system

3-4. Game of Skill, easy to maintain, Suitable for all ages

4. HOW TO PLAY

- 1) When you insert coins and bills that the game is played.
- 2) Players simply press the start/drop button to align rings and magic stones on top of each other, finally the flag to build the castle.
- 3) First stage is completed by dropping 3 magic rings aligned with the pole.
- 4) Second stage is completed by stacking magic stones on top of each other.
- 5) Carefully place the spire-shaped stone to complete the castle.
- 6) Put up a flag at the top of castle stone! Then it put life into castle.



[WARNING]

Please make sure LOCK and IO USB should be put in right place as following picture. It may lead malfunction of machine in case it's located in wrong place.

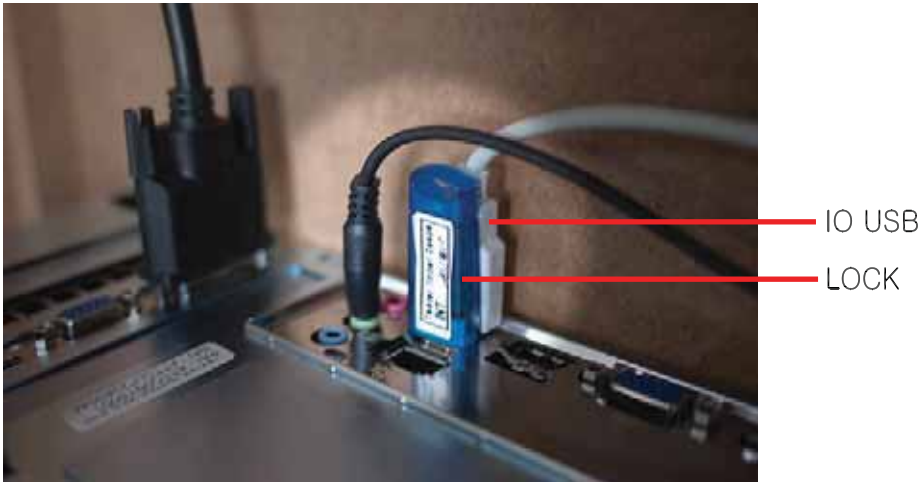

5. SETUP SETTINGS

5-1. MACHINE SETUP

(1) HOW TO ENTER SETUP MENU

- 1 There is "Control panel" inside cabinet. User may set any setting using following.

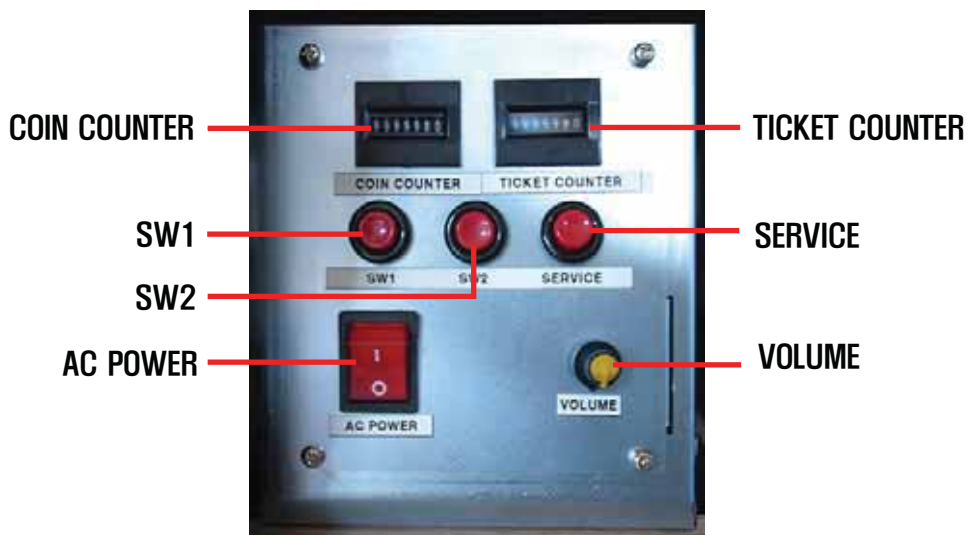

[CONTROL PANEL]

[BUTTON DESCRIPTION]

- 1) **SW1** : "Setup mode" button and "Up" button.
- 2) **SW2** : "Down" button.
- 3) **SERVICE** : "Select" button.

6. SETUP MENU

Select your own settings on installation of the game.

Press SW1 Button to enter setup mode.

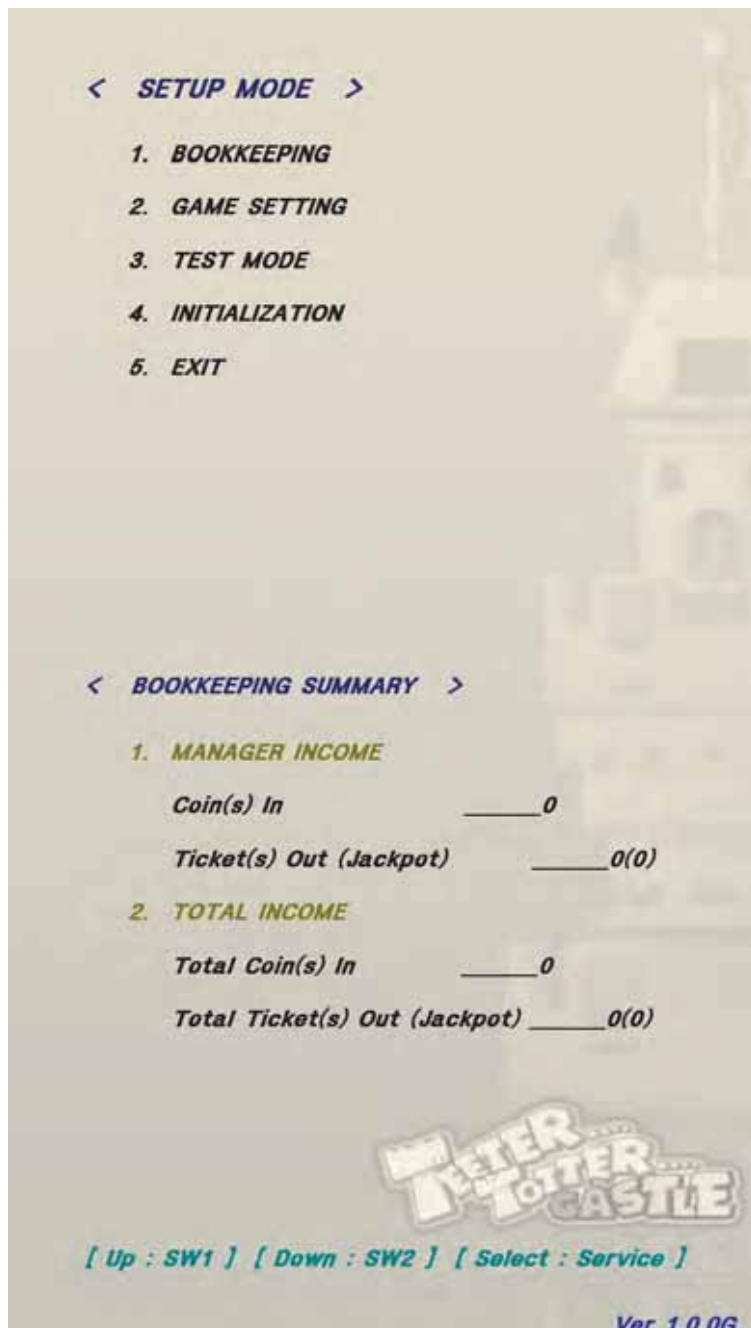

<SETUP MODE>

- Bookkeeping, game setting, test mode, and initialization.

<SHORTCUT VIEW>

- Summary of coin(s) in, ticket(s) out, and number of plays.

1. MANAGER INCOME

: Coin(s) in, ticket(s) out (Jackpot ticket out), and number of plays since last initialization.

2. TOTAL INCOME

: Displays total accumulated coin(s) in, ticket(s) out (Jackpot ticket out), and number of plays from the start.



6-1. BOOKKEEPING

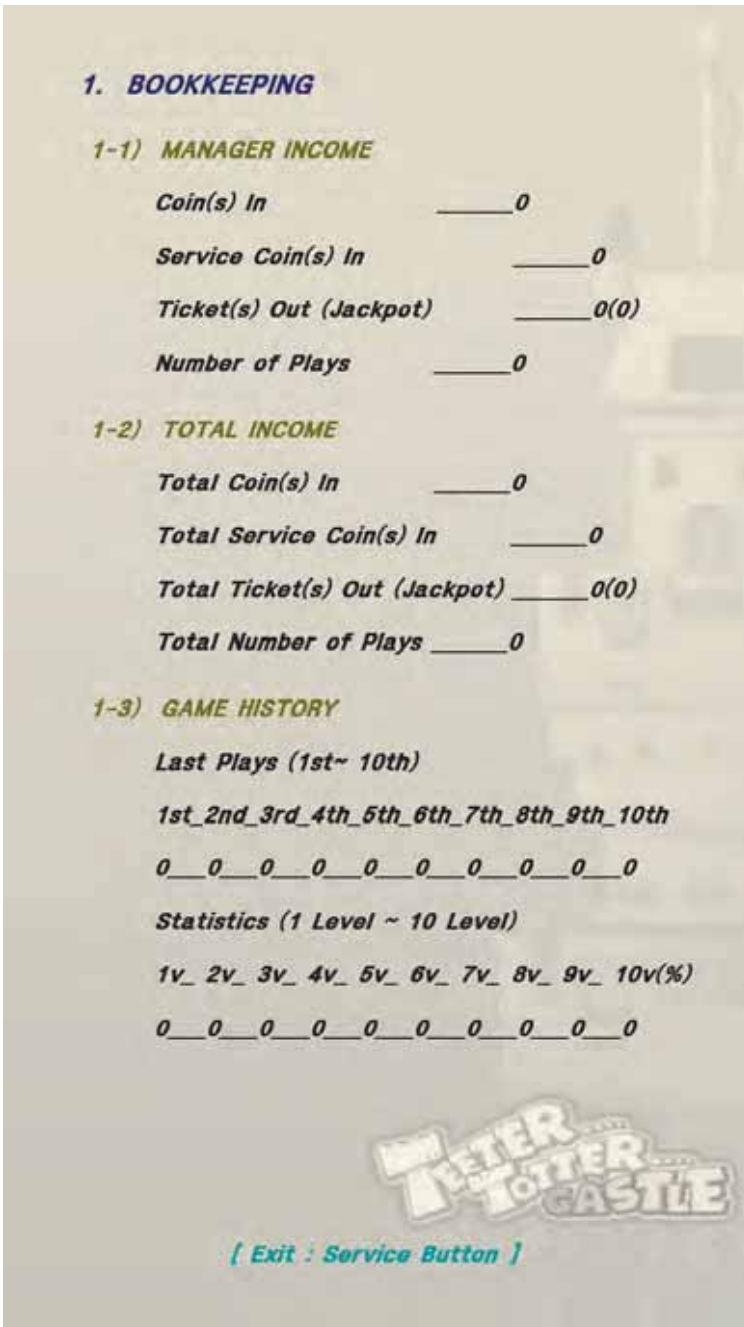

1-1) MANAGER INCOME

Coin(s) in, ticket(s) out (Jackpot ticket(s) out), and number of plays since last initialization.

1-2) TOTAL INCOME

Displays total accumulated coin(s) in, ticket(s) out(Jackpot ticket(s) out), and number of plays from the start.

1-3) GAME HISTORY

Displays ten most recent plays.
1st is the last played.
Statistics displays the % of successful completion of each block.



6-2. GAME SETTING

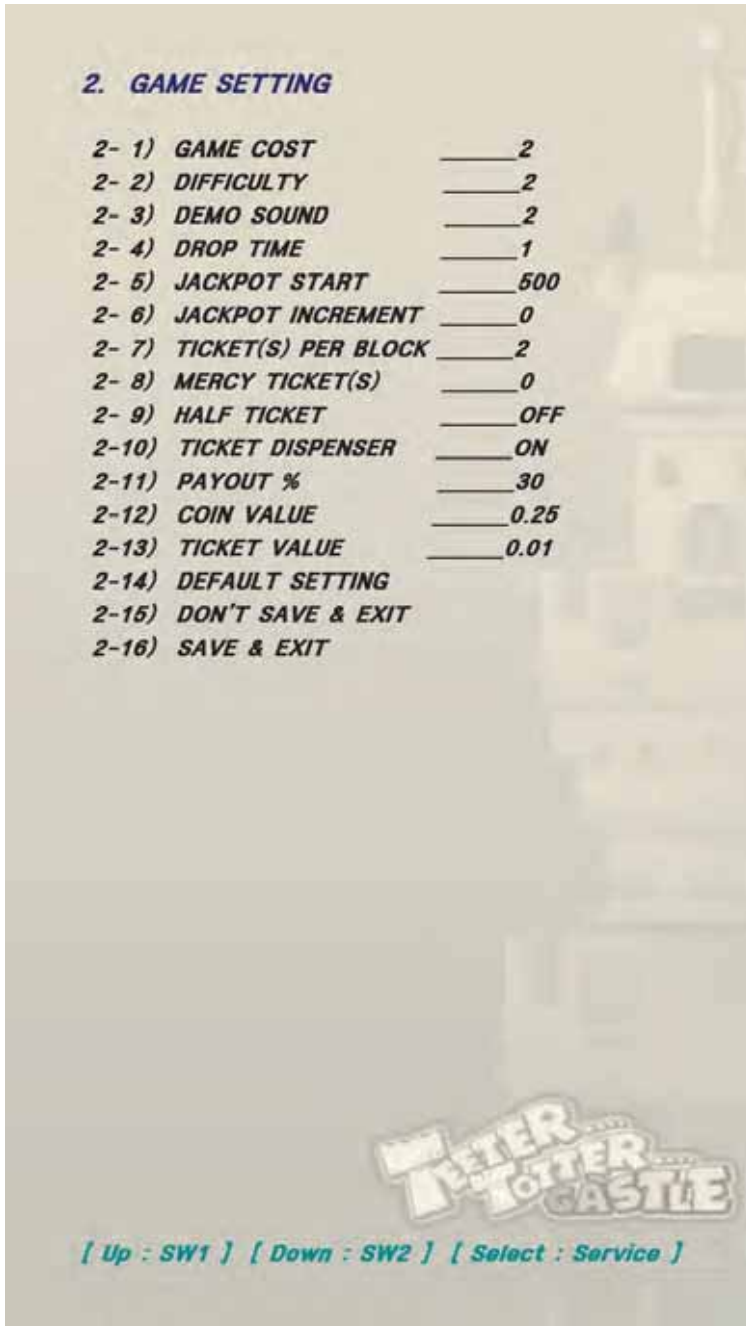

2-5) JACKPOT START

Set up the beginning Jackpot value.
Select from 0-1,000 in increments of 10.
Please check 2-7)TICKET(S) PER BLOCK for maximum Jackpot limit.

2-6) JACKPOT INCREMENT

Set up Jackpot increment per play.
Select from 0-10.
Please check 2-7)TICKET(S) PER BLOCK for maximum Jackpot limit.

2-7) TICKET(S) PER BLOCK

Set up the number of ticket(S) pay out for each block.

2-8) MERCY TICKET(S)

Set up Mercy Ticket(s) pay out.
Select from 1-10.

2-9) HALF TICKET

Turn on to give half ticket(s) won.

2-10) TICKET DISPENSER

ON : To turn on Ticket Dispenser
OFF : To turn off Ticket Dispenser

2-11) PAYOUT %

SET UP PAYOUT RATE FROM 15-60%.

2-12) COIN VALUE

Select coin value from \$0.01-\$20.00.

2-13) TICKET VALUE

Select ticket value from \$0.01-\$5.00.

2-14) DEFAULT SETTING

Yes to turn on default setting, No to exit.

2-15) DON'T SAVE & EXIT

2-16) SAVE & EXIT

2-1) GAME COST

Set up coin(s) in per play.

2-2) DIFFICULTY

Set up difficulty level.

2-3) DEMO SOUND

Set up demo sound.

2-4) DROP TIME

Set up the time limit for each block.



2-1) GAME COST

2-1 Game Cost	
1	= 1 Coin 1 Play
2	= 2 Coin(s) 1 Play
3	= 3 Coin(s) 1 Play
4	= 4 Coin(s) 1 Play
5	= 5 Coin(s) 1 Play
6	= 6 Coin(s) 1 Play
7	= 8 Coin(s) 1 Play
8	= 9 Coin(s) 1 Play
9	= 10 Coin(s) 1 Play
10	= 12 Coin(s) 1 Play
11	= FREE PLAY

2-2) DIFFICULTY

2-2 Difficulty	
1	= 1 Jackpot in 100 Plays
2	= 1 Jackpot in 200 Plays
3	= 1 Jackpot in 300 Plays
4	= 1 Jackpot in 400 Plays
5	= 1 Jackpot in 500 Plays
6	= 1 Jackpot in 600 Plays
7	= 1 Jackpot in 700 Plays
8	= 1 Jackpot in 800 Plays
9	= 1 Jackpot in 900 Plays
10	= 1 Jackpot in 1000 Plays
11	= 1 Jackpot in 1500 Plays
12	= 1 Jackpot in 2000 Plays
13	= 1 Jackpot in 3000 Plays

2-3) DEMO SOUND

2-3 Demo Sound	
1	= OFF
2	= Always On
3	= Every 10 Min
4	= Every 15 Min
5	= Every 20 Min
6	= Every 25 Min



2-4) DROP TIME

2-4 Drop Time	
1	= 10 SEC
2	= 15 SEC
3	= 20 SEC
4	= 25 SEC
5	= 30 SEC
6	= NO TIME LIMIT

2-7) TICKET(S) PER BLOCK

2-7 Ticket Per Block	
<Warning> By selecting one of 'Ticket(s) Per Block' preset options 1-8, Difficulty, Jackpot Start, & Payout % are automatically changed to preset values in the table	
1	= 0 1 1 2 2 2 3 3 5 100(Jackpot)
2	= 0 1 2 3 5 7 10 15 30 500(Jackpot)
3	= 0 2 3 5 7 10 20 30 70 1000(Jackpot)
4	= 0 3 5 10 15 20 30 50 100 2000(Jackpot)
5	= 0 1 2 2 3 3 4 5 10 100(Jackpot)
6	= 0 1 2 2 3 3 4 5 10 200(Jackpot)
7	= 0 1 2 3 5 7 10 20 40 500(Jackpot)
8	= 0 1 2 3 4 5 10 20 50 500(Jackpot)

<Warning> By selecting one of 'Ticket(s) Per Block' preset options 1~8, Difficulty, Jackpot Start, & Payout % are automatic changed to preset value in the table.

TICKET(S) PER BLOCK	1F	2F	3F	4F	5F	6F	7F	8F	9F	JACKPOT	REQUIRED GAME COST
1	0	1	1	2	2	2	3	3	5	100	1COIN (25 cent)
2	0	1	2	3	5	7	10	15	30	500	2COIN (50 cent)
3	0	2	3	5	7	10	20	30	70	1000	4COIN (1 dollar)
4	0	3	5	10	15	20	30	50	100	2000	8COIN (2 dollar)
5	0	1	2	2	3	3	4	5	10	100	1COIN (25 cent)
6	0	1	2	2	3	3	4	5	10	200	1COIN (25 cent)
7	0	1	2	3	5	7	10	20	40	500	2COIN (50 cent)
8	0	1	2	3	4	5	10	20	50	500	2COIN (50 cent)

* Value Table

TICKET(S) PER BLOCK	DIFFICULTY	JACKPOT START	PAYOUT %
1	1	100	20
2	2	500	30
3	2	1000	30
4	2	2000	30
5	1	100	20
6	2	200	30
7	2	500	30
8	2	500	30



6-3. TEST MODE

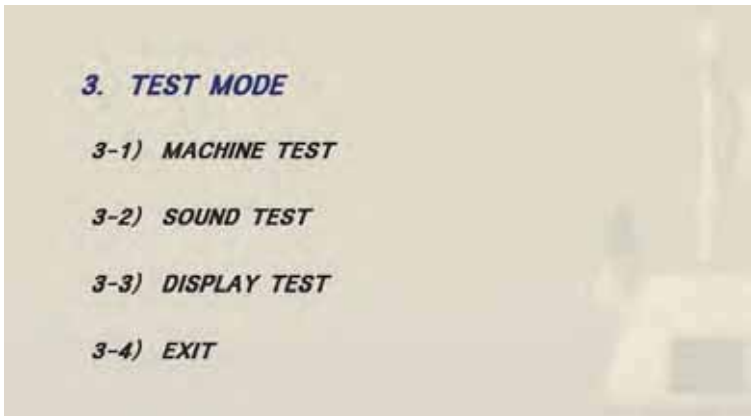

3-1) MACHINE TEST

Shows test readings from coin-mech, ticket dispenser, play button, coin counter, ticket counter, and LEDs.

3-2) SOUND TEST

Shows test readings for background music, coin up sound, and winning sound.

3-3) DISPLAY TEST

Test monitor condition.

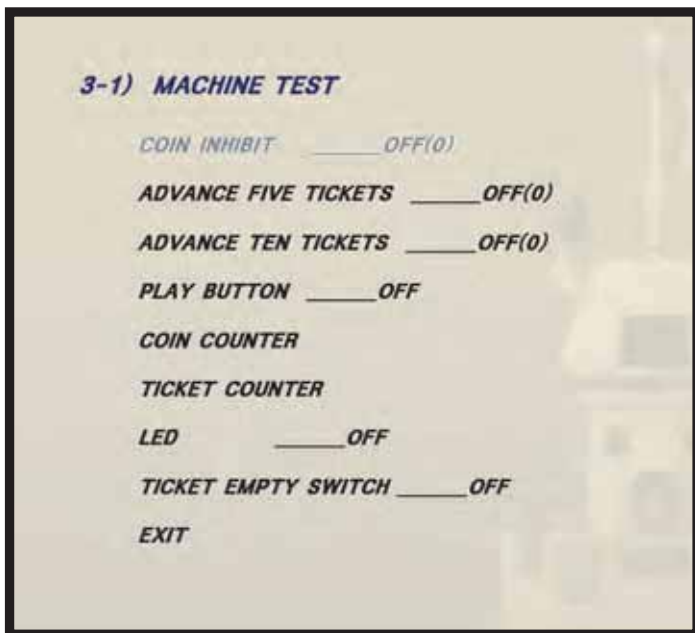

- COIN INHIBIT
: Turn on to reject the coin(s) when game is at malfunction.
- ADVANCE FIVE TICKET
: Turn on to dispense 5 tickets.
- ADVANCE TEN TICKET
: Turn on to dispense 10 tickets.
- PLAY BUTTON
: Press "PLAY" button to test
- TICKET COUNTER
: Ticket Counter goes up by one when selected.
- LED
: Turn on to test monitor LED and button LED.
- TICKET EMPTY SWITCH
: Display the condition of Ticket Empty Switch.
(On, Off, Empty)
- EXIT

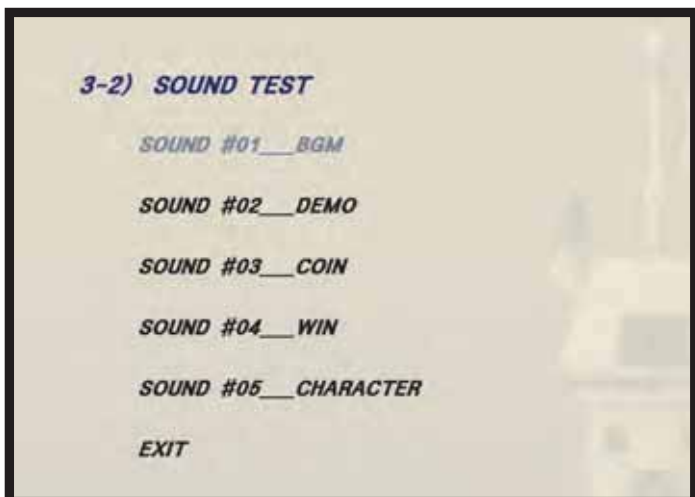

3-3) DISPLAY TEST

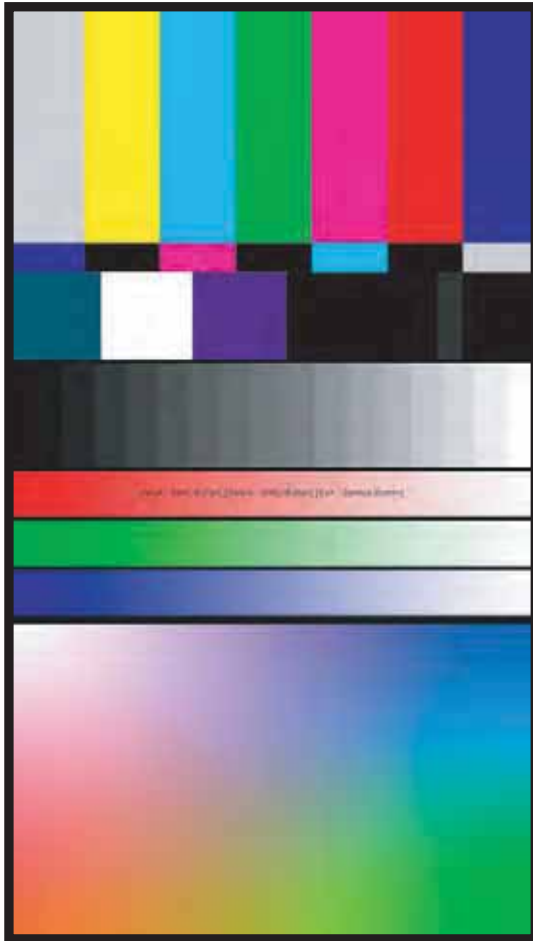

6-4. INITIALIZATION

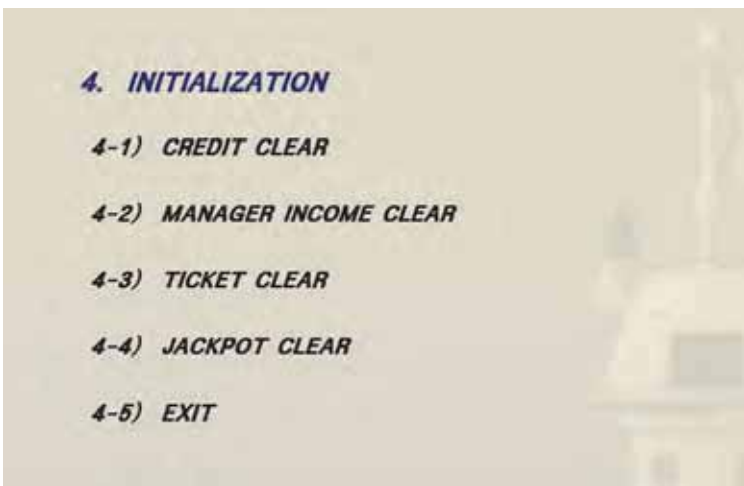

4-1) CREDIT CLEAR

Clears current credit(s).
Press yes to clear, or no to exit.

4-2) MANAGER INCOME CLEAR

Clears Manager Income.
Press yes to clear, or no to exit.

4-3) TICKET CLEAR

Clears ticket(s) owed.
Press yes to clear, or no to exit.

4-4) JACKPOT CLEAR

Clears current jackpot.
Press yes to clear, or no to exit.

4-5) EXIT



6-5. ERROR MESSAGE

- 1) **LOCK CHECK FAILED!!!** [Drop button does not work when this error message appear on the screen]

: Please make sure USB lock(BLUE) is inserted firmly and re-boot the system.
: It may occur when it does not match between Game Version and USB lock version :
we have several game version depend on language.

- 2) **I/O COMMUNICATION ERROR :**



: Please make sure USB connector from Main Box & I/O board is inserted stably and check LED on I/O board [One should be lit on and another one blink once a second]

* If the above check for the error message disappears.

- 3) **Credit Limit**

– We have a credit limitation for safety.
In case the number of credit comes to 21, "Credit limit" message appear on the screen and whole input signals are blocked [Drop button, Coin acceptor]
: In order to clear this error, please initialize credit at
4-1) CREDIT Clear in Setup mode.



: In case this error message occur continuously.
Please contact Our C/S tesm [tcs@andamiro.com]

7. HOW TO REPLACE MAJOR COMPONENTS

● REPLACEMENT OF BUTTON LED PCB ASS'Y & BUTTON

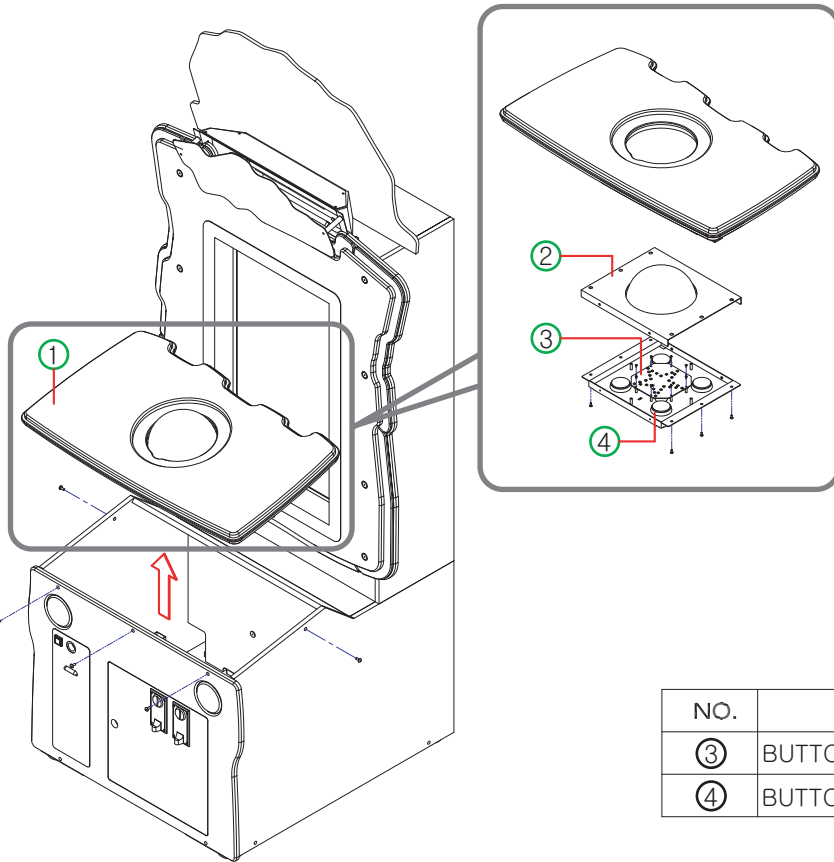

- (1) Take off ①BUTTON PANEL ASS'Y (M6 bolt, 4ea) and disconnect connectors.
- (2) Take off ②BUTTON COVER PLATE (M6bolt, 6ea)
- (3) Resemble them in reverse order after replacing ③BUTTON LED PCB ASS'Y & ④BUTTON ASS'Y

NO.	PART NAME	SPEC.	CODE NO.
③	BUTTON LED PCB ASS'Y	-	ATTC0PCB003
④	BUTTON ASS'Y	AM1PB-26SH R12D	MMUM0BUT002

● REPLACEMENT OF MAIN BOX & IO & DISPLAY MAIN PCB ASS'Y

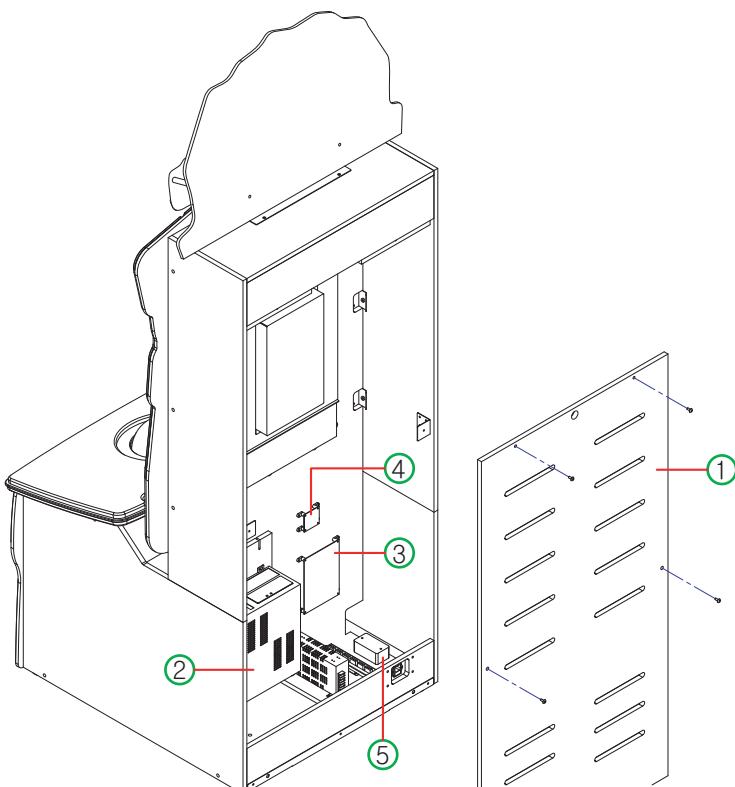

- MAIN BOX

- (1) Opening the ①rear door, You may find ②MAIN BOX.
- (2) Replacing them after disconnecting all connectors from Main box. [M4Bolt, 4ea]

- IO & DISPLAY MAIN PCB ASS' Y

- (1) Likewise Main box, you may find ③USB IO PCB ASS'Y & ④DISPLAY MAIN PCB ASS'Y when you open the rear door.
- (2) Replace it after disconnecting all connectors, (M4 bolt, 4ea)

NO.	PART NAME	SPEC.	CODE NO.
②	MAIN BOX ASS'Y	TTC GT440 2GB	ATTC0SYS001
③	USB I/O PCB ASS'Y	-	ATTC0PCB001
④	DISPLAY MAIN PCB ASS'Y	-	ATTC0PCB002

● REPLACEMENT OF FRONT LIGHT DECO PCB ASS'Y

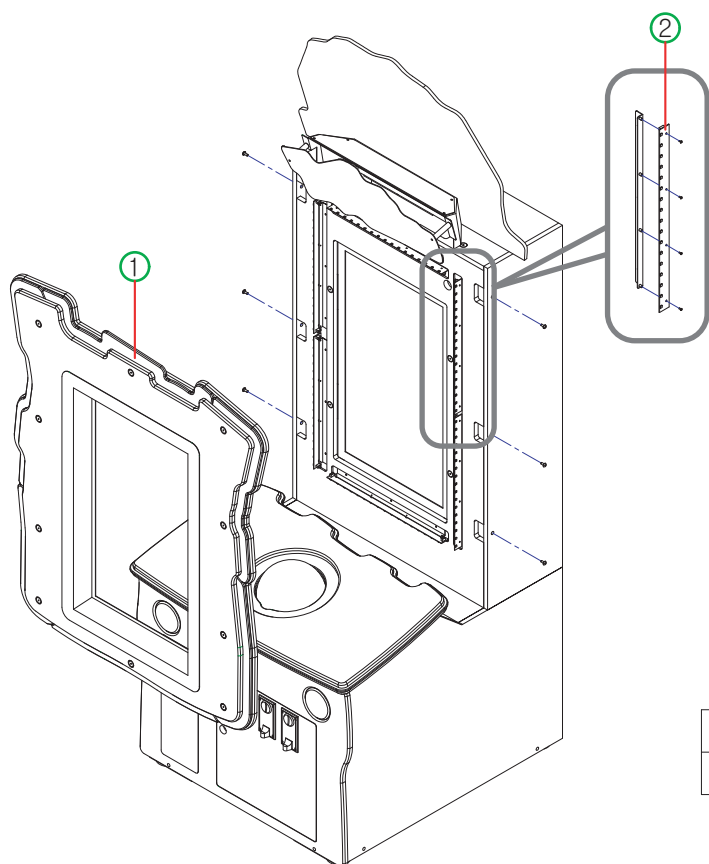

- (1) Disassemble ① MONITOR DECO PAENL ASS'Y [M6 bolt, 6ea]
- (2) You may find ② FRONT LIGHT DECO PCB ASS'Y after taking off the MONIOR DECO PANEL ASS'Y
- (3) Replace it after disconnecting all connectors and reassemble them in reverse order.

NO.	PART NAME	SPEC.	CODE NO.
②	FRONT LIGHT DECO PCB ASS'Y	-	APCX0PCB001

8. HOW TO REPLACE CONSUMABLES

● REPLACEMENT OF LAMP

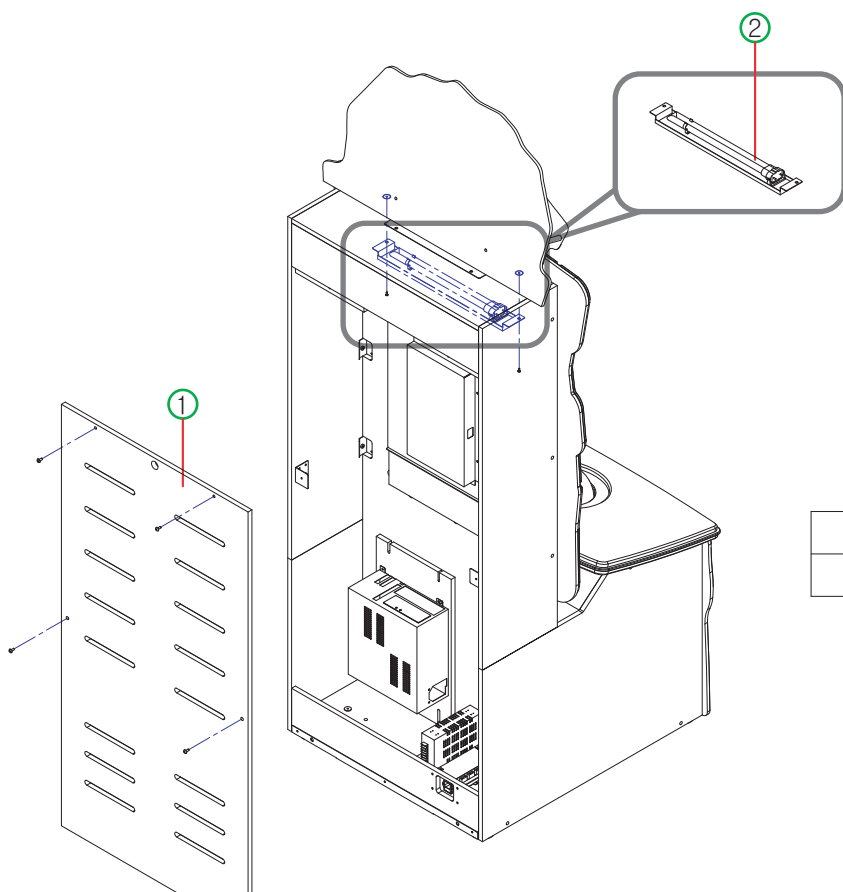

- (1) There is Lamp ass'y in upper part of cabinet after opening ① rear door. [M6 bolt, 2ea]
- (2) Resemble it in reverse order after replacing ② LAMP.

NO.	PART NAME	SPEC.	CODE NO.
②	LAMP	FPL36W	MELE0LAM028

9. TROUBLESHOOTING

9-1. SCREEN PROBLEM

*Common: Check the input voltage, check wiring

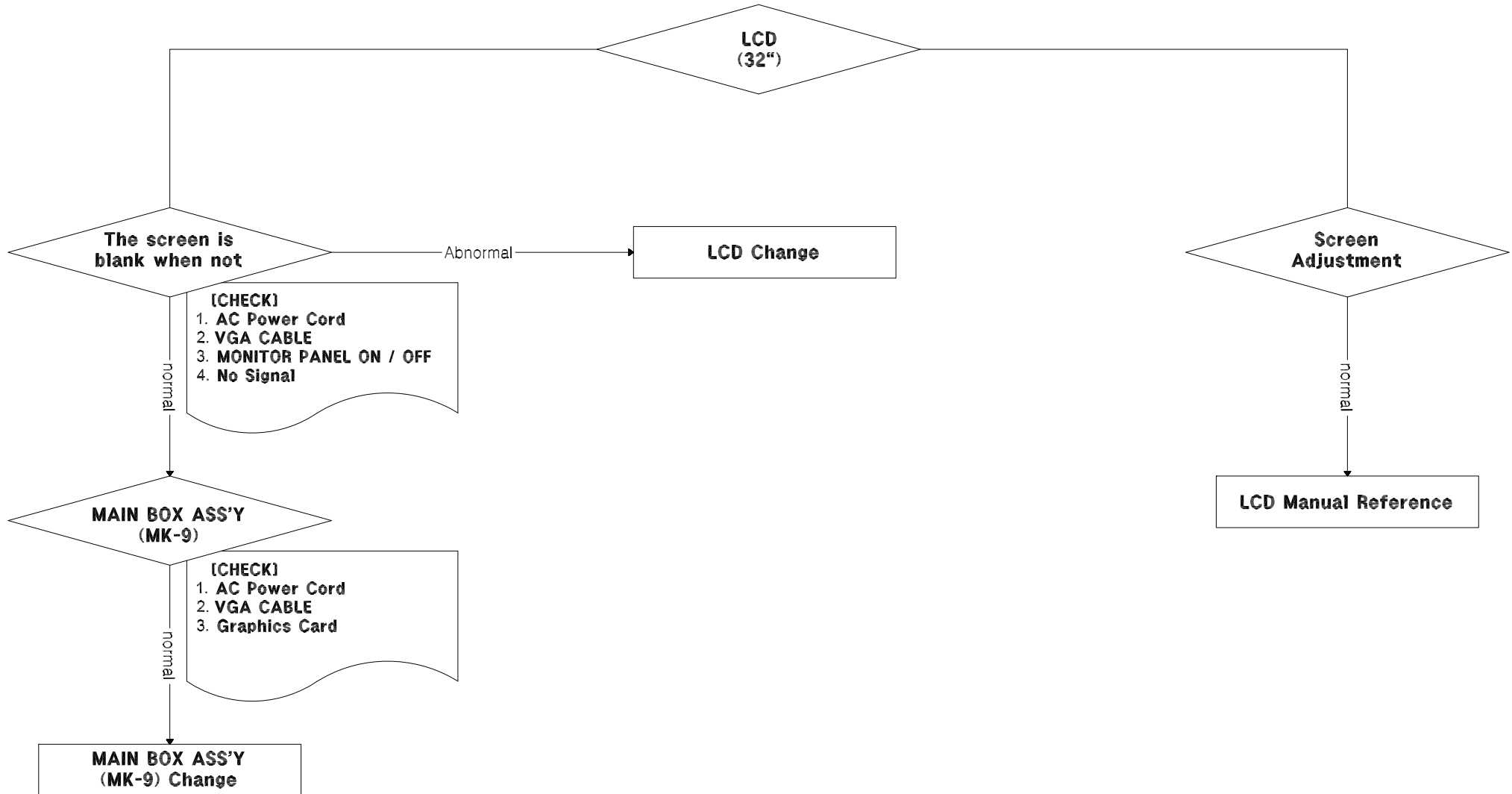

9-2. SOUND ERROR

*Common: Check the input voltage, check wiring

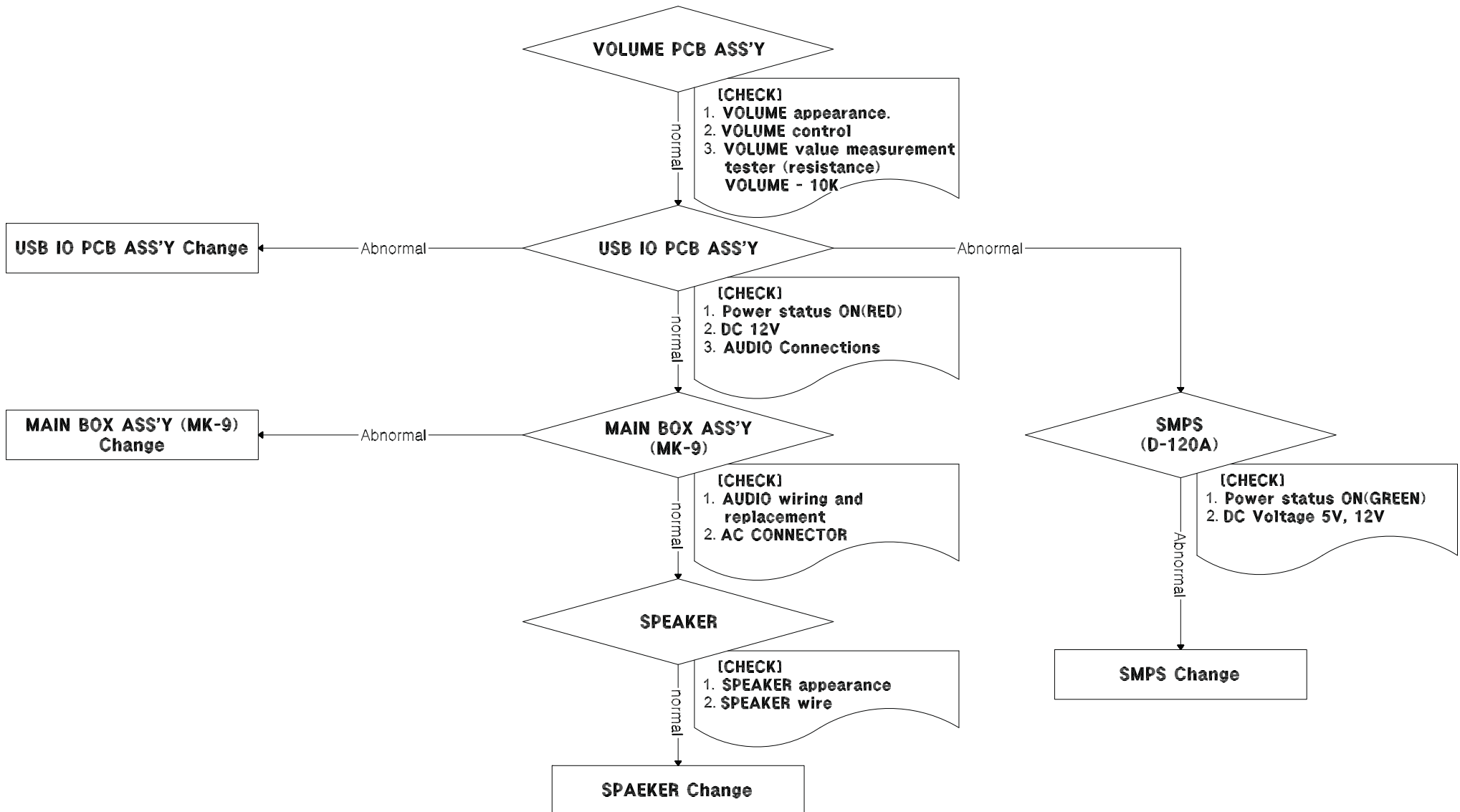

9-3. AC LAMP ERROR

*Common: Check the input voltage, check wiring

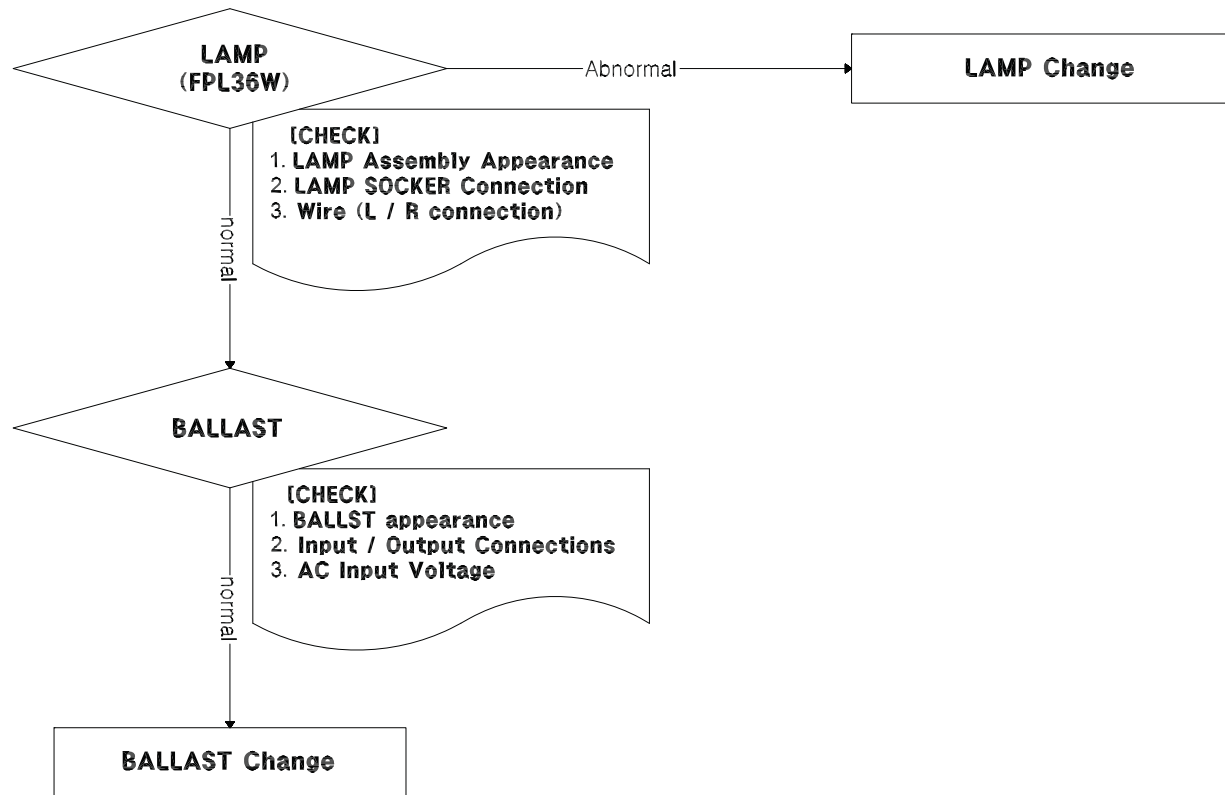

9-4. OUT OF POWER

*Common: Check the input voltage, check wiring

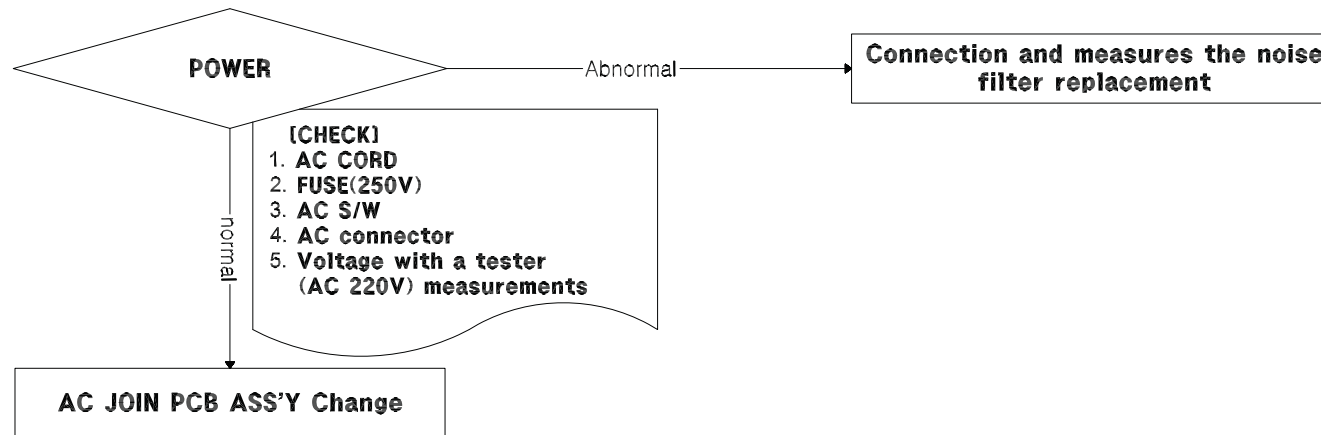

9-5. COIN SELECTOR ERROR

*Common: Check the input voltage, check wiring

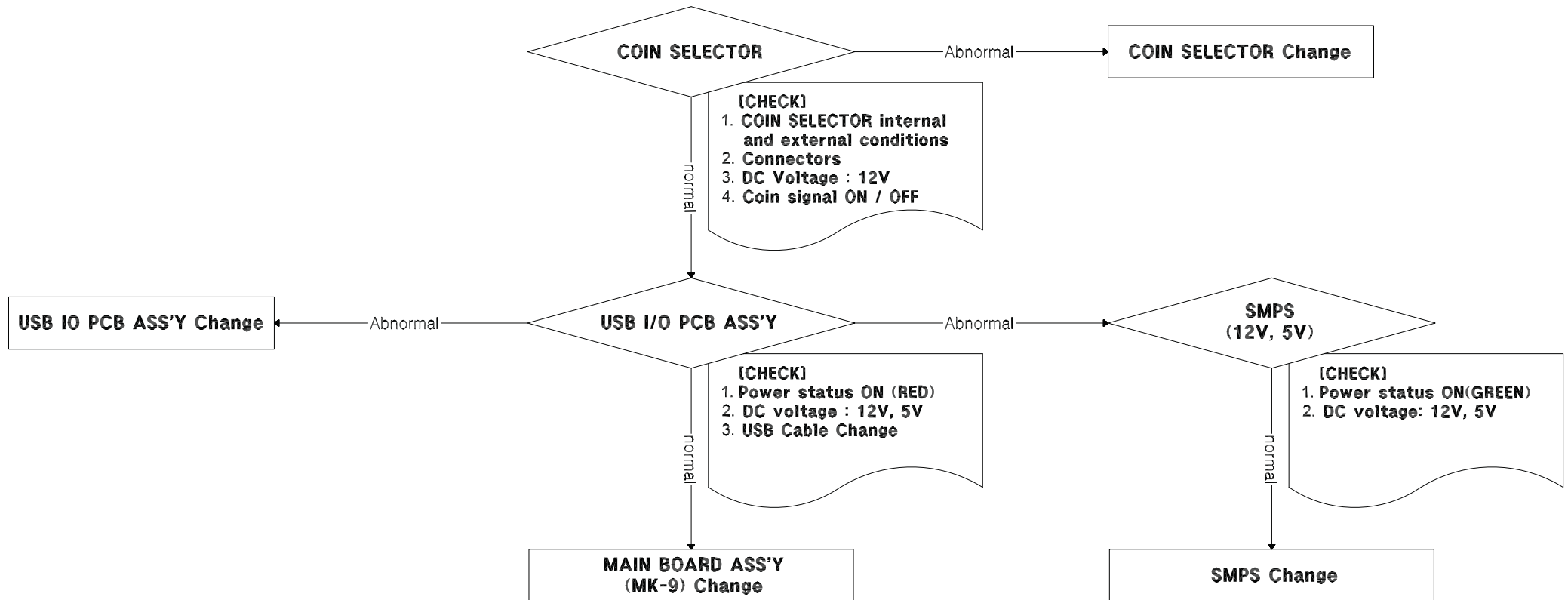

9-6. BUTTON & COUNTER ERROR

*Common: Check the input voltage, check wiring

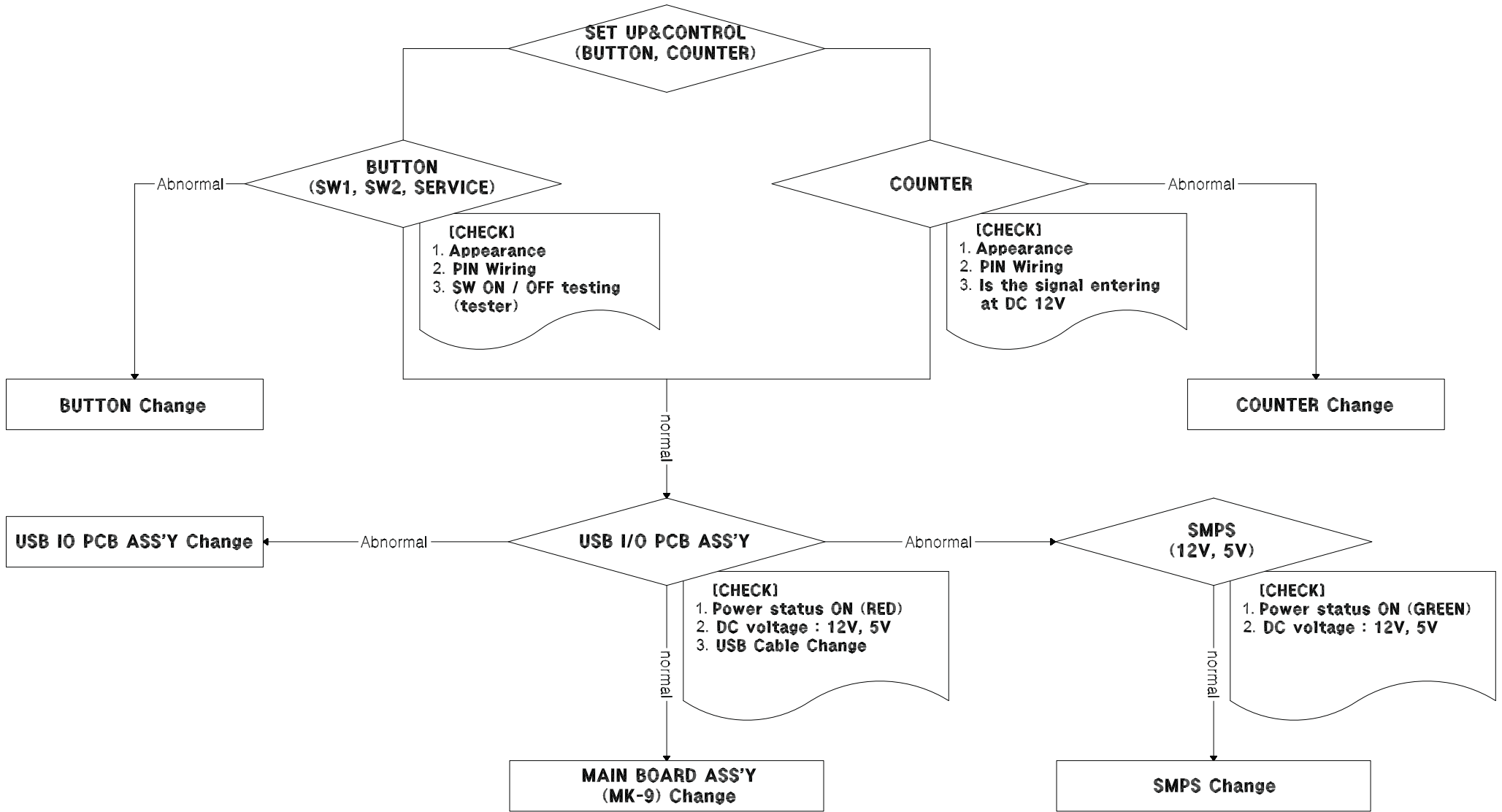

9-7. MALFUNCTION OF WHEN BUTTON LED PCB & FRONT LIGHT DECO PCB ASS'Y

*Common: Check the input voltage, check wiring

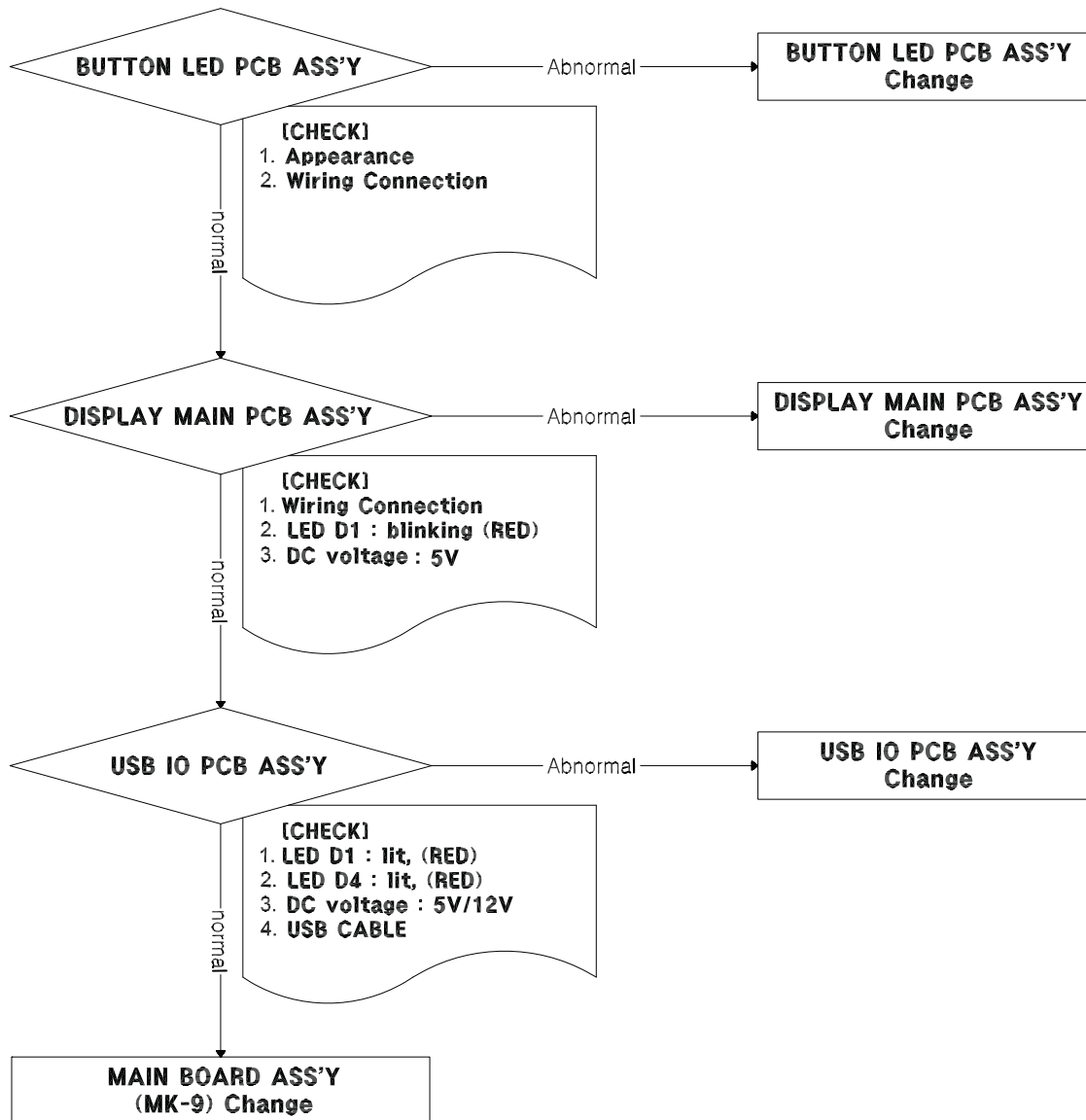

9-8. MALFUNCTION OF TICKET DISPENSER

*Common: Check the input voltage, check wiring

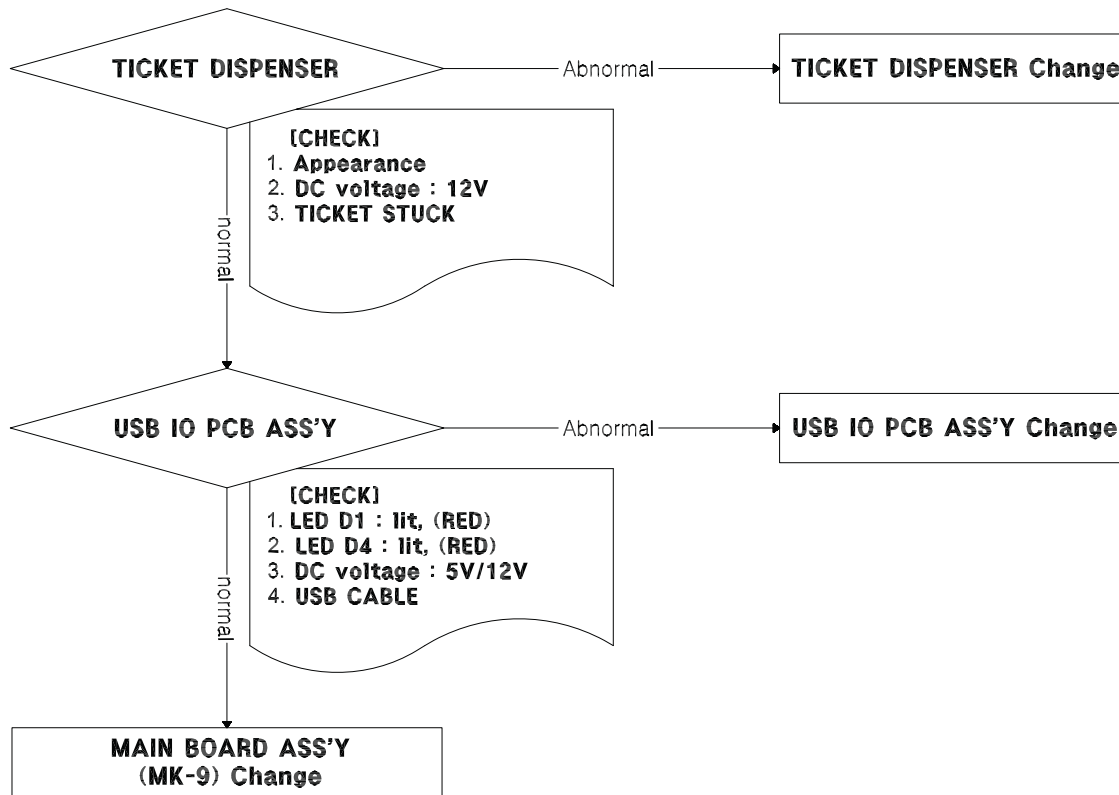

10. PARTS LIST

10-1. EXPLODED VIEW

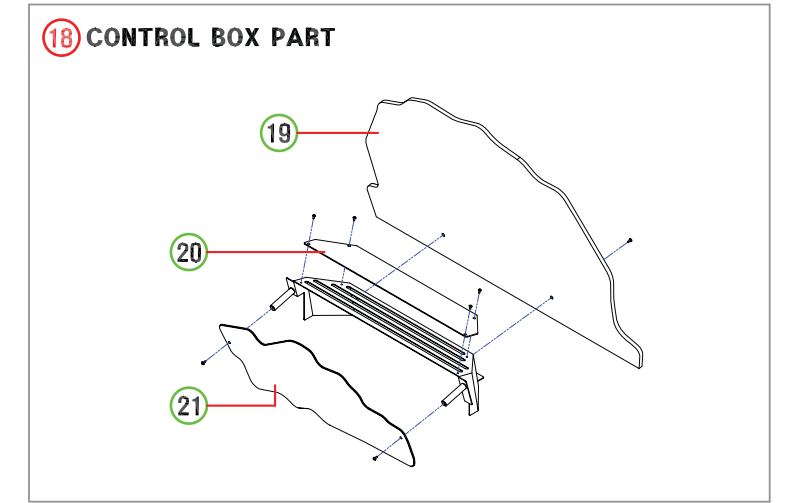
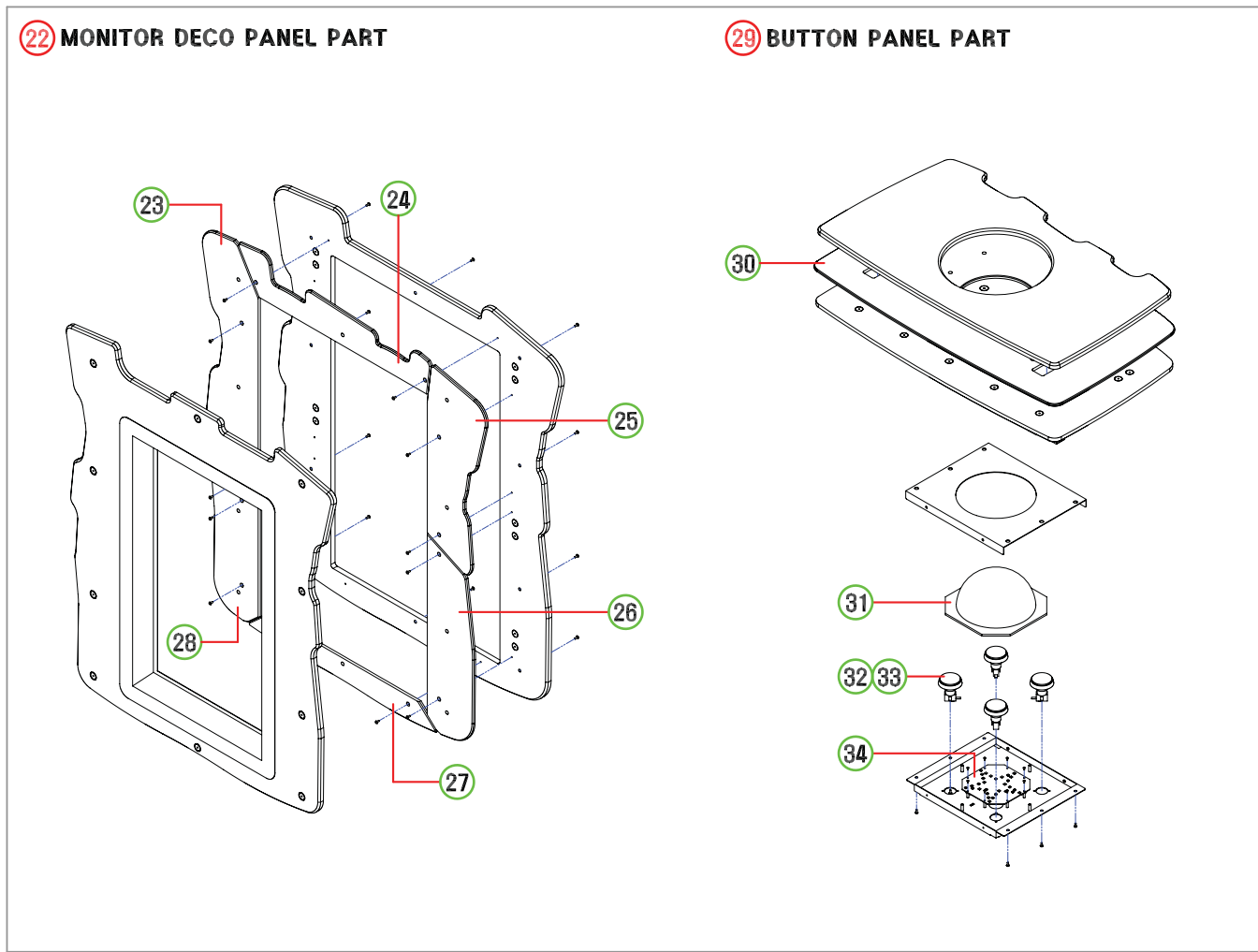

1 MAIN CABINET PART

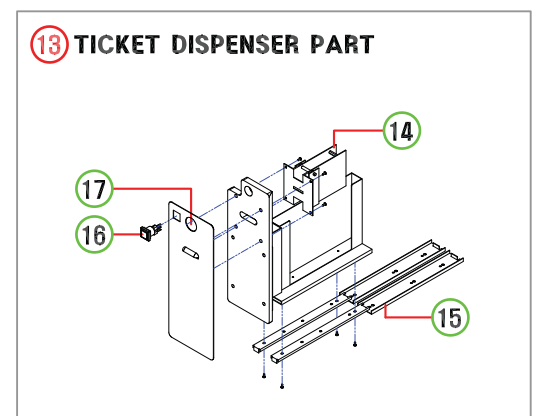
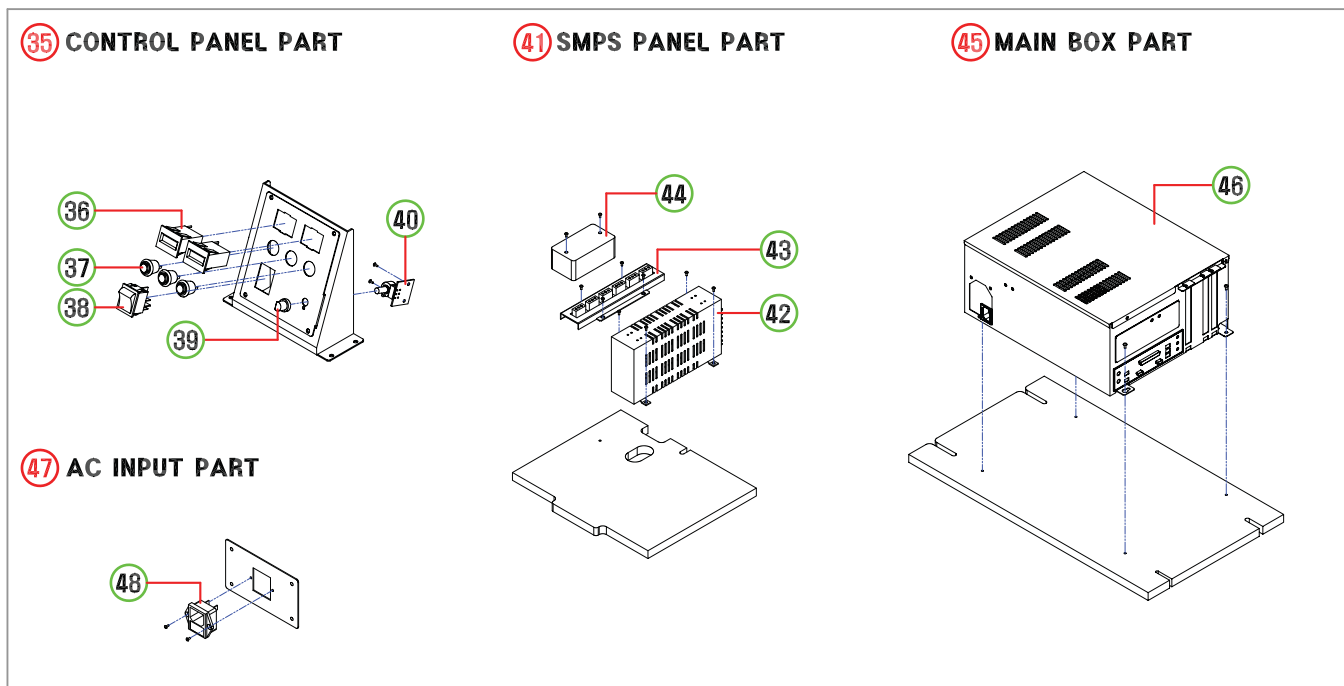
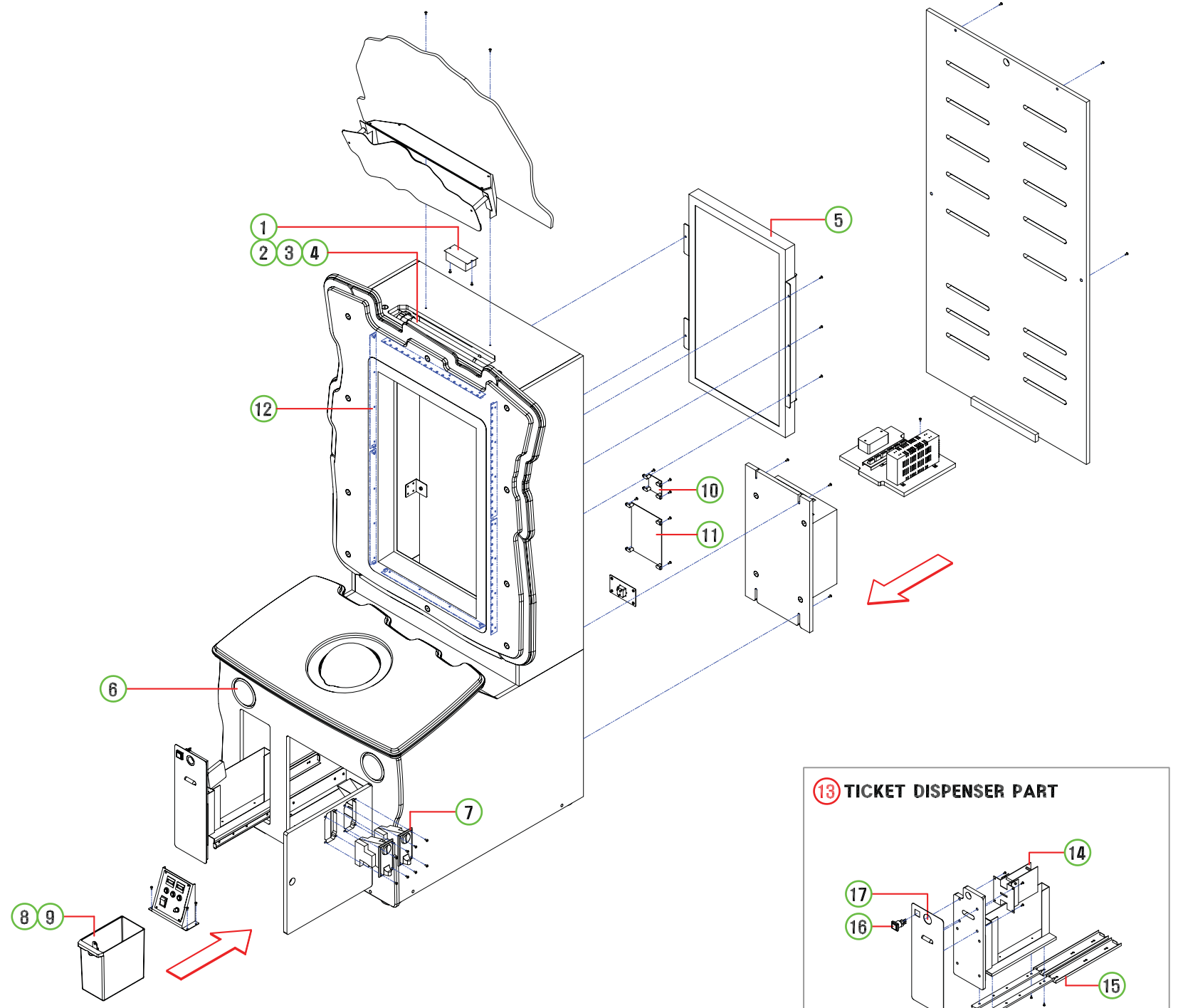

































10-2. LIST

NO.	PIC	LEVEL	PART NAME	SPEC.	QTY	CODE NO.
①		1	MAIN CABINET PART			
②	○	2	ELECTRONIC BALLAST	FPL36W_TWIN_220V	1	MELE0BAL016
③		2	FPL LAMP SOCKET ASS'Y	FPL36W_SWING	1	AELE0S0C001
④	○	2	LAMP	FPL36W WHITE	1	MELE0LAM028
⑤	○	2	LCD MONITOR	32" OPEN FRAME	1	ATTC0LCD001
⑥	○	2	SPEAKER	MID 4.5"+TW 8Ω	2	MZZZ0SPE021
⑦	○	2	COIN SELECTOR	TW-130B	1	MZZZ0C0S032
⑧	○	2	COIN BOX	BLACK	1	MDRE0PLA007
⑨		2	KEY ASS'Y	6001	1	MZZZ0KEY041
⑩	○	2	DISPLAY MAIN PCB ASS'Y	-	1	ATTC0PCB002
⑪	○	2	USB IO PCB ASS'Y	-	1	ATTC0PCB001
⑫	○	2	FRONT LIGHT DECO PCB ASS'Y	-	6	APCX0PCB001
⑬		1	TICKET DISPENSER PART			
⑭	○	2	TICKET DISPENSER	TH-002H	1	MZZZ0TID007
⑮	○	2	GUIDE RAIL	300mm	2	MMUM0000004
⑯		2	BUTTON	AMIPB-26HS-R12D	1	MMUM0BUT002
⑰		2	KEY ASS'Y	7001	1	MZZZ0KEY032
⑱		1	BILLBOARD PART			
⑲	○	2	BILLBOARD REAR POP	FOMAX-10.0t	1	MTTTC0ACR008
⑳	○	2	BILLBOARD BKT COVER ACRYL	PET-2.0t	1	MTTTC0ACR009
㉑		2	BILLBOARD FRONT	ACRYL-3.0t	1	MTTTC0ACR010
㉒		1	MONITOR DECO PANEL PART			
㉓	○	2	MONITOR DECO ACRYL-C	ACRYL-8.0t [MILK]	1	ATTC0ACR003
㉔	○	2	MONITOR DECO ACRYL-B	ACRYL-8.0t [MILK]	1	ATTC0ACR002
㉕	○	2	MONITOR DECO ACRYL-A	ACRYL-8.0t [MILK]	1	ATTC0ACR001
㉖	○	2	MONITOR DECO ACRYL-F	ACRYL-8.0t [MILK]	1	ATTC0ACR006
㉗	○	2	MONITOR DECO ACRYL-E	ACRYL-8.0t [MILK]	1	ATTC0ACR005
㉘	○	2	MONITOR DECO ACRYL-D	ACRYL-8.0t [MILK]	1	ATTC0ACR004
㉙		1	BUTTON PANEL PART			
㉚	○	2	BUTTON DECO ACRYL	ACRYL-8.0t	1	MTTTC0ACR001
㉛		2	DOME ACRYL	φ200	1	MTTTC0PLA001
㉜		2	BUTTON SWITCH	AM1PB-60HR-W12D _with out LED	4	MZZZ0BUT087
㉝	○	2	BUTTON LED PCB ASS'Y	-	1	ATTC0PCB003
㉞		1	CONTROL PANEL PART			
㉟	○	2	COUNTER	AMMC-712(7D12V)	2	MZZZ0COU002

NO.	PIC	LEVEL	PART NAME	SPEC.	QTY	CODE NO.
⑳	○	2	PUSH BUTTON SWITCH	DS-421R	3	MELE0PUS006
㉑	○	2	ROCKER SWITCH	T-125 4P	1	MELE0SWI004
㉒	○	2	VOLUME KNOB	-	1	MELE0VOL007
㉓	○	2	VR PCB ASS'Y	-	1	AHM20PCB016
㉔		1	SMPS PANEL PART			
㉕	○	2	POWER SMPS	D-120A 12V,5V	1	MELE0SMP045
㉖	○	2	AC JOIN PCB ASS'Y	-	1	AZZZ0PCB100
㉗	○	2	NOISE FILTER	ESI-F10	1	MELE0NOI006
㉘		1	MAIN BOX PART			
㉙	○	2	MAIN BOX	TTC GT440 2GB	1	ATTC0SYS001
㉚		1	AC INPUT PART			
㉛	○	2	AC INPUT ASS'Y	DAC_13H, FUSE 10A_2EA	1	AEKE0FUS002
Parts for 110V						
㉜	○	2	ELECTRONIC BALLAST	FPL36W_ONE_110V	1	MELE0BAL025

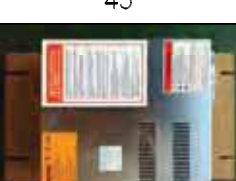
10-3. PICTURE

2	4	5	6	7	8
					
10	11	12	13	14	19
					
20	21	23	24	25	26
					
27	28	30	33	35	36
					
37	38	39	41	42	43
					
45	47				
					

MARK	DATE	REVISION	DRAWN BY	CHECKED BY	APPROVED BY

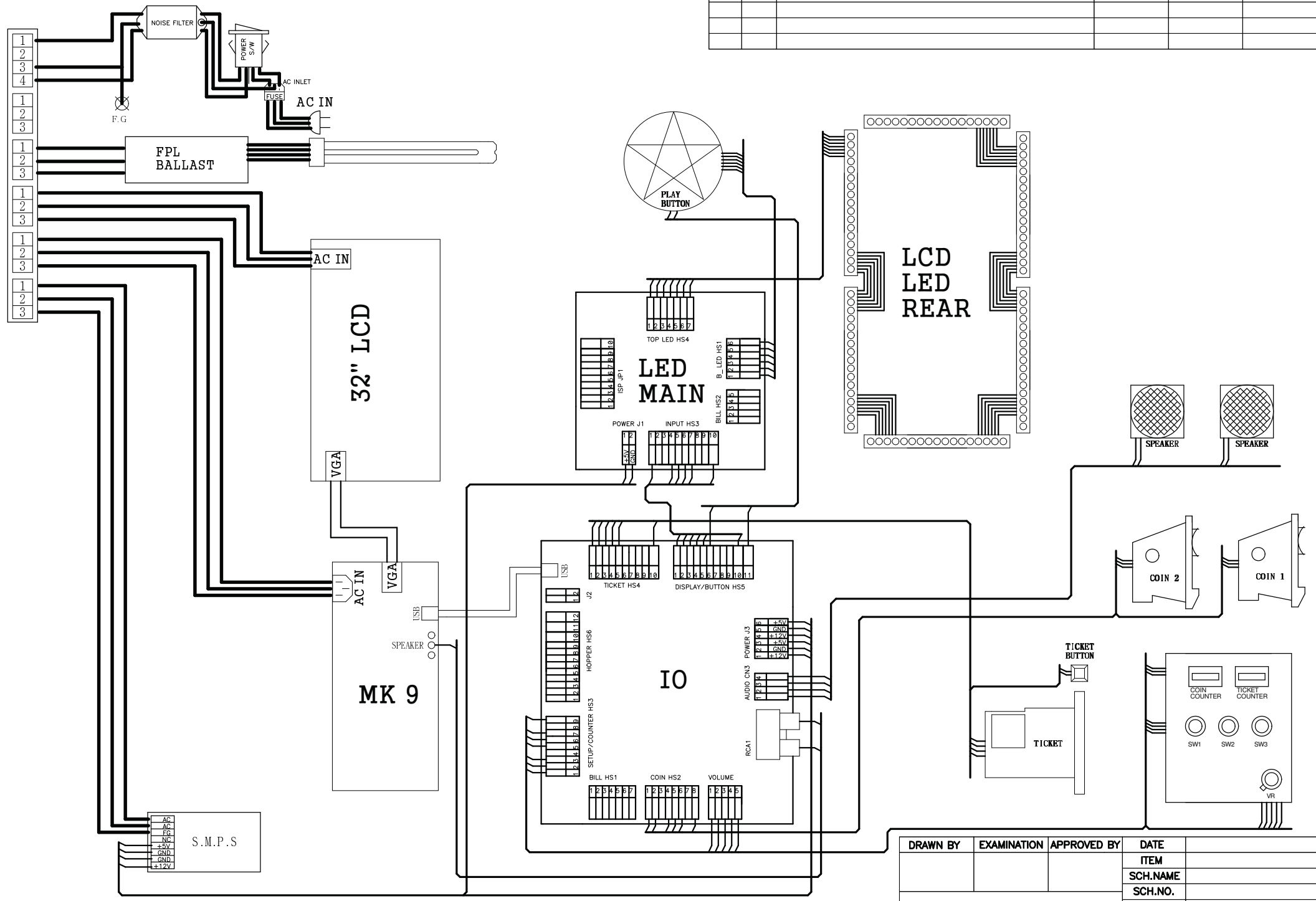

DRAWN BY	EXAMINATION	APPROVED BY	DATE
			ITEM
			SCH.NAME
			SCH.NO.
			CODE.NO.



ANDAMIRO CO., LTD.

TEL : 82-31-909-2123~4,2051

[ADDRESS OFFICE] 6006 M-City Tower, 195, Baengmaro, Ilsandong-gu, Koyang-si,
Kyonggi-do, 410-834 Korea

[FACTORY] 72 Nochemgil, Ilsan-donggu koyang-si, kyonggi-do, 410-834 korea

USA BRANCH

ANDAMIRO USA CORP.

17230 S. Main Street

TEL : 1-310-767-5800

[ADDRESS] Gardena, California 90248 U.S.A.

Homepage <http://www.andamiro.com/>