

2. INSTALLATION

2-1. INSTALLATION SPACE

- Need to have installation place.
Maintenance zone & Play zone should have at least 1400mm x 2400mm each.

***IMPORTANT**

- Once you set up the machine with required game-play area, when installing this product, set the 4 leg levelers evenly on the floor and make sure that the product is installed stably in a horizontal position.

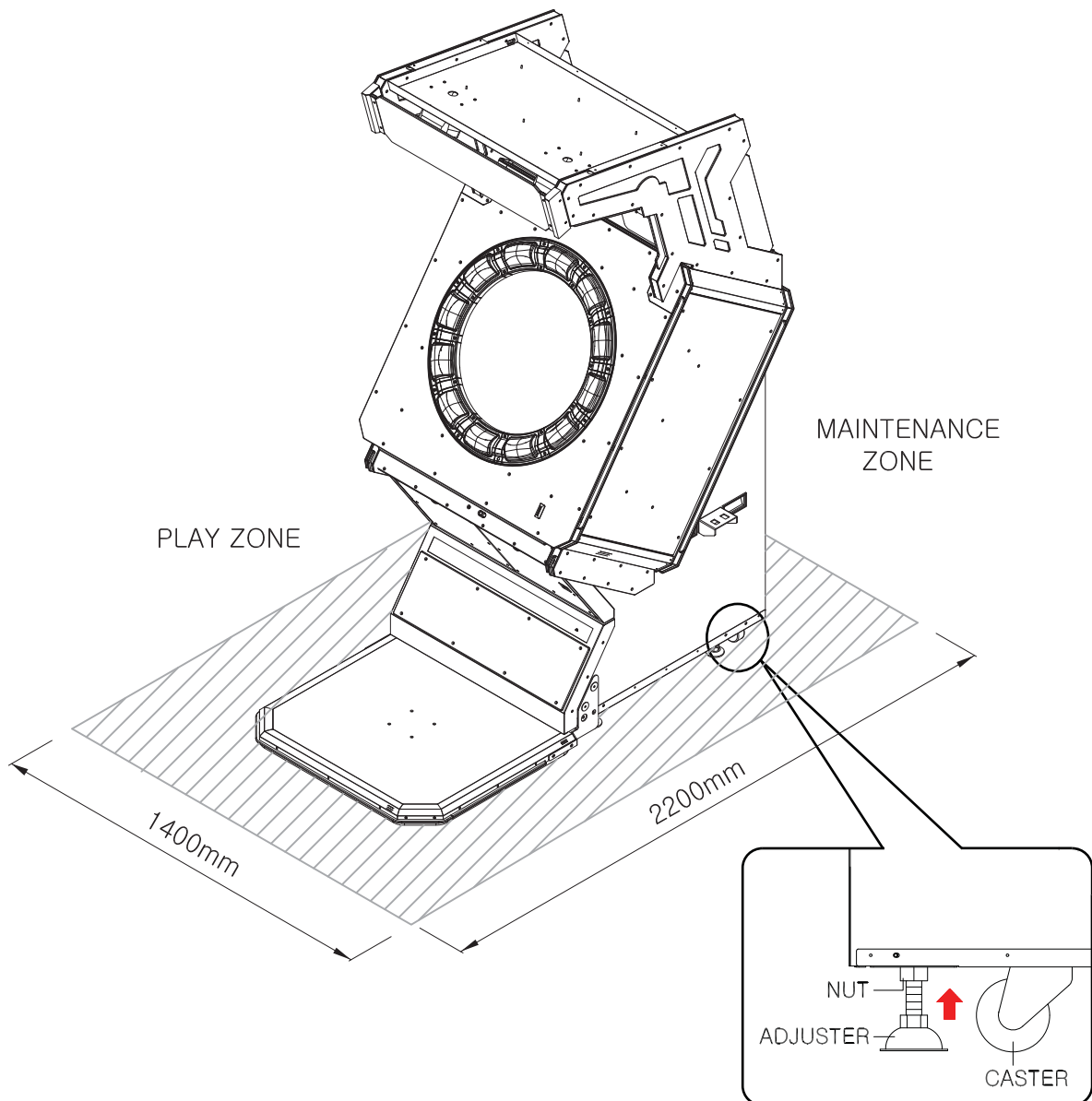

2-2. HOW TO INSTALL [PACKING]



※ PARTS (location - Speaker panel box)

no	PART NAME	Q'TY	SPARE	NOTE
P1	AC POER CARD	1		
P2	RFID CARD	3		
P3	MANUAL	1		
P4	WRENCH 2.5mm	1		
P5	SCREW - SEMS M4*6L	2	4	POP ACRYL
P6	SCREW - SEMS M6*16L	14	10	B_BASE BKT SPEAKER BKT
P7	SCREW - SEMS M6*25L	10	5	B_SIDE L/R
P8	SCREW - FLAT RENCH M4*10L	36	9	B_SIDE L/R
P9	SCREW - LH_BLACK M6*12L	14	6	SPEAKER BOX
P10	SCREW -TH_BLACK M4*8L	11	9	POP ACRYL B_TITLE COVER
P11	SCREW - LH_NI M6*20L	4	6	FOOTBAARD
P12	WASHER_NI M4*16	2	4	POP ACRYL
P13	FOOTBOARD CASE FIX BKT L	1		
P14	FOOTBOARD CASE FIX BKT R	1		
P15	FOOTBOARD FIX WASHER BKT	4		WHITE
P16	B_TITLE ACRYLE COVER BKT	2		
P17	KEY 6001	1		
P18	KEY 7001	1		
P19	ERROR CODE	1		
P20	SCREW - LH_NI M6*12L	4	4	FOOTBOARD
P21	SCREW -TH_NI M4*8L	2	6	B_ACRYL

※ B_ = BILLBOARD



2-3. HOW TO INSTALL [BILLBOARD]



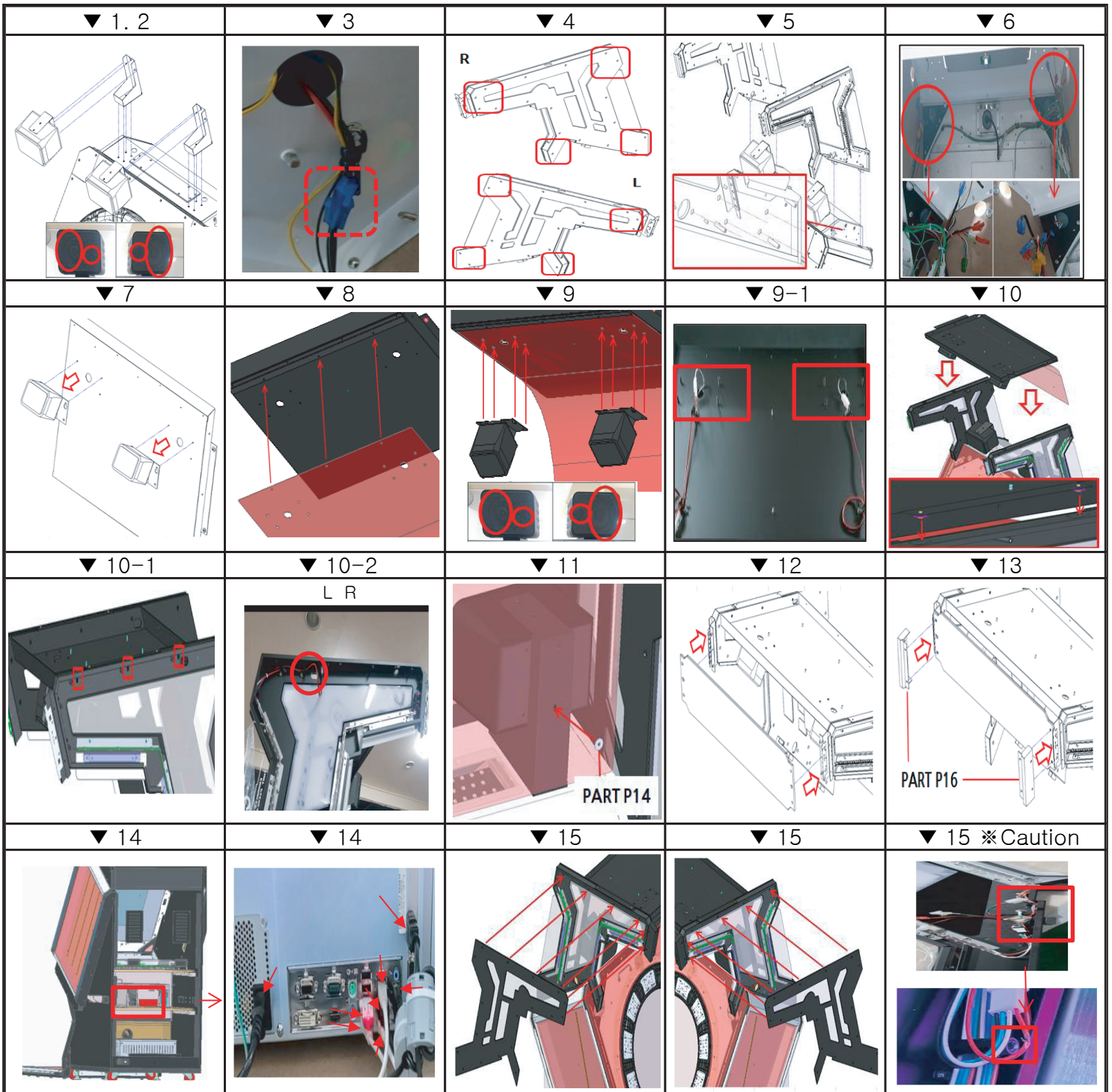

no	PROCESS	ITEM	TYPE	SCREW	Q'ty	no	PROCESS	ITEM	TYPE	SCREW	Q'ty
1	ASSEMBLE	SPEAKER BKT L/R	SEMS	M6*16L	8	10-1	ASSEMBLE	B_ L / R ASS'Y	SEMS	M6*16L	6
2	ASSEMBLE	SPEAKER BOX L/R	LH_BLACK	M6*12L	6	10-2	CONNECT	L R WIRING			2
3	CONNECT	WIRING			2	11	ASSEMBLE	B_ POP ACRYL	SEMS	M4*6L	2
4	REMOVE	B_ L/R SIDE ACRYL	WRENCH	M4*10L	-8			WASHER			2
5	ASSEMBLE	B_ L/R ASS'Y	SEMS	M6*25L	10	12	ASSEMBLE	B_ TITLE ACRYL	TH_NI	M4*8L	2
6	CONNECT	WIRING			8	13	ASSEMBLE	B_ TITLE SIDE COVER	TH_BLACK	M4*8L	8
7	REMOVE	B_ SPEAKER L / R	LH_BLACK	M6*12L	-4	14	CHECK	Check for Wiring Out (Open the back door)			8
8	ASSEMBLE	B_ POP ACRYL	TH_BLACK	M4*8L	3		* CAUTION - Wiring Out				
9	ASSEMBLE	B_ SPEAKER L/R	LH_BLACK	M6*12L	8	15	ASSEMBLE	B_ L R SIDE ACRYL	WRENCH	M4X10L	36
9-1	CONNECT	WIRING			2		* CAUTION (WIRING) -Pay attention to wiring when fixing screws				

* B_ = BILLBOARD

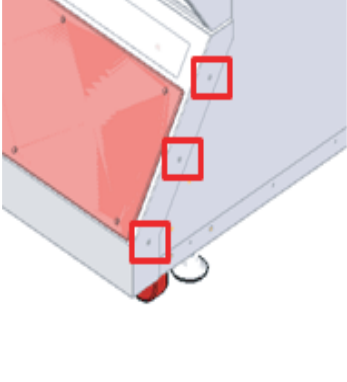
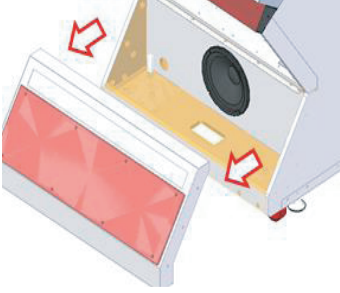

2-4. HOW TO INSTALL [FOOTBOARD]

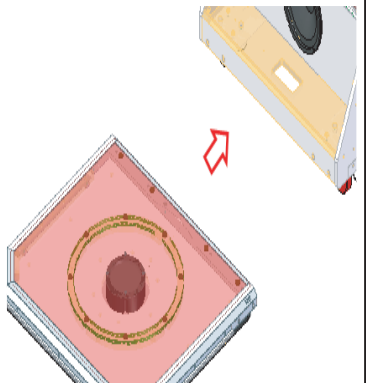
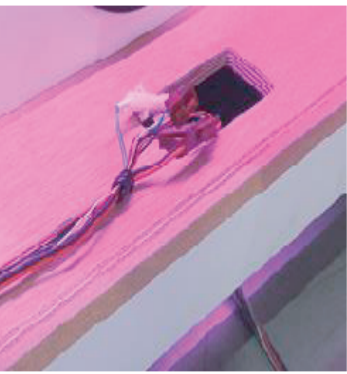
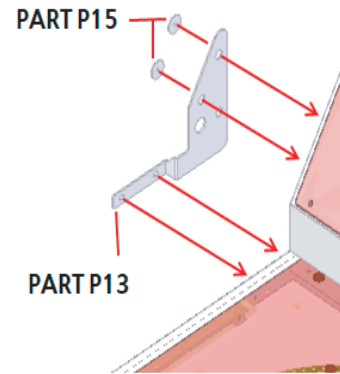
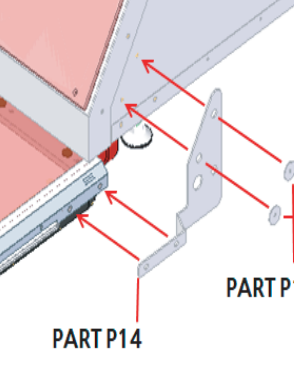
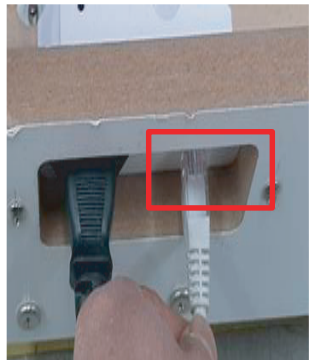
no	PROCESS	ITEM	TYPE	SCREW	Q'ty
16	REMOVE	WOFFER COVER ASS'Y	SEMS	M6*16L	6
17	CAUTION	FG CONNECTION WIRING			1
18	ASSEMBLE	FOOTBOARD ASS'Y			1
19	CONNECT	INTERNAL WIRING			4
20	ASSEMBLE	FOOTBOARD CASE FIX BKT L	LH_NI	M6*12L	2
	ASSEMBLE	FOOTBOARD CASE FIX BKT L	LH_NI	M6*20L	2
21	ASSEMBLE	FOOTBOARD CASE FIX BKT R	LH_NI	M6*12L	2
	ASSEMBLE	FOOTBOARD CASE FIX BKT R	LH_NI	M6*20L	2
22	CONNECT	Connect the store's internet line			
23	POWER ON	ROCKER S/W - ON			
24	MOVE	Press the arrow and turn 360 degrees to the right.			
25	SETUP SETTING	See Manual			

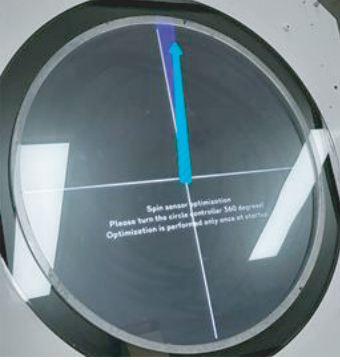
▼ 16	▼ 16	▼ 17	▼ 18
			
▼ 19	▼ 20	▼ 21	▼ 22
			
▼ 23	▼ 24	▼ 25	
		SETUP SETTING	